

elit **Metal**
Sistemleri
EXPERT ON RAILING SYSTEMS

<p>C50 Top Mount Glass Supporting System Page→ 04-07</p>	<p>LED C50 Top Mount Glass Supporting System Page→ 08-11</p>	<p>C50+ Top Mount Glass Supporting System Page→ 12-13</p>	<p>A50 Top Mount Glass Supporting System Page→ 14-15</p>
<p>U50 Top Mount Glass Supporting System Page→ 16-17</p>	<p>U50F Top Mount Glass Supporting System Page→ 18-19</p>	<p>U50Max Top Mount Glass Supporting System Page→ 20-21</p>	<p>U50FMax Top Mount Glass Supporting System Page→ 22-23</p>
<p>U50RMax Top Mount Glass Supporting System Page→ 24-25</p>	<p>EX50 Top Mount Glass Supporting System Page→ 26-27</p>	<p>X50 Top Mount Glass Supporting System Page→ 28-29</p>	<p>N50S Top Mount Glass Supporting System Page→ 30-31</p>
<p>N50 Top Mount Glass Supporting System Page→ 32-33</p>	<p>N50F Top Mount Glass Supporting System Page→ 34-35</p>	<p>N50R Side Fix System Page→ 36-37</p>	<p>C70 Top Mount Supporting System with Glass Angle Adjustment Page→ 38-39</p>
<p>C60 Top Mount Glass Supporting System Page→ 40-41</p>	<p>AS55 Top Mount Glass Supporting System Page→ 42-43</p>	<p>R50Neo Top Mount Glass Supporting System Page→ 44-45</p>	<p>FX50 Side Fix System Page→ 46-47</p>
<p>NX50 Top Mount Glass Supporting System Page→ 48-49</p>	<p>M50 F Type Top Mount Glass Supporting System Page→ 50-51</p>	<p>CL50 Top Mount Glass Supporting System Page→ 52-53</p>	<p>CL40 Top Mount Glass Supporting System Page→ 54-55</p>
<p>DESIGN RX50 Top Mount Glass Supporting System Page→ 56-57</p>	<p>CA50 In-Floor Glass Supporting System Page→ 58-61</p>	<p>CX50 Top Mount Glass Supporting System Page→ 62-63</p>	<p>D50 Side Mount Staircase Type Glass Railing Page→ 64-65</p>

<p>D55 Bendable Side Fix Glass Railing System Page→ 66-67</p>	<p>AL50 External Glass Supporting System Page→ 68-69</p>	<p>S40 Top Mount Glass Supporting System (Economic Type) Page→ 70-71</p>	<p>S40E Top Mount Glass Supporting System (Economic Type) Page→ 72-73</p>
<p>J100 Juliete Balcony Page→ 74-75</p>	<p>J120 Juliete Balcony Page→ 76-77</p>	<p>Vista100 External Glass Supporting System Page→ 78-79</p>	<p>Vista300 Vista310 Spigot System Page→ 80-81</p>
<p>Vista320 Vista330 Spigot System Page→ 82-83</p>	<p>TOP RAIL PROFILE VARIATIONS & ACCESSORIES Page→ 84-85</p>	<p>HANDRAILS & ACCESSORIES Page→ 86-87</p>	<p>ACCESSORIES Page→ 88</p>

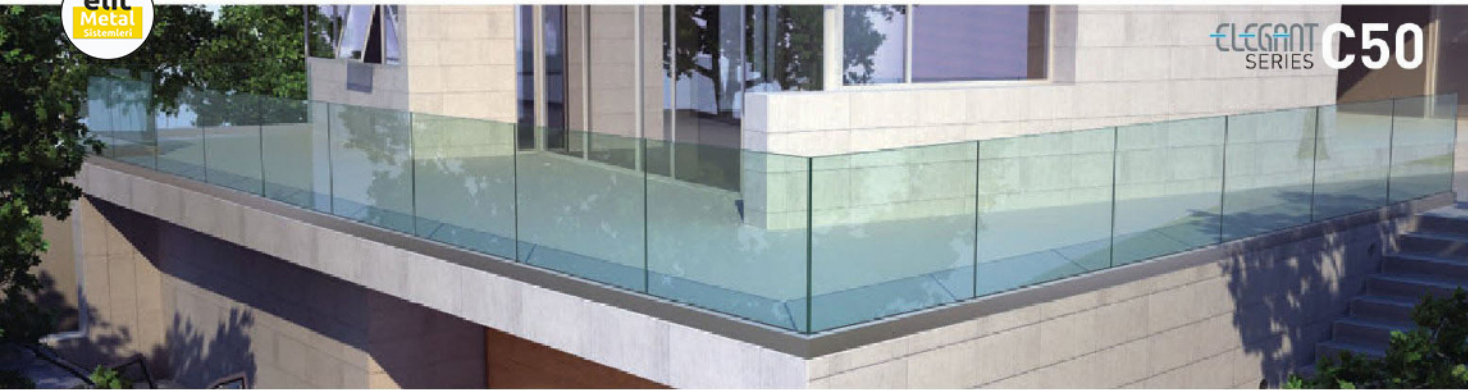

C50

Mass/Block/Masse: 9.87846 kg
Volume/Volumen/Volume: 0.000517958 m³
Density/Dichte/Densité: 2700 kg/m³
Weight/Gewicht/Poids/Force: 13.7052 N

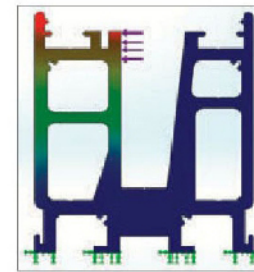
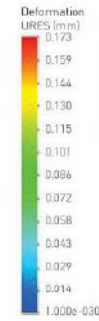

Alloy EN AW 6063
Stress and relocation results on 1m base profile with 1 tone (10.000 nt) horizontal load to the highest surface of the profile.

Belastungs- und Verlagerungsergebnisse auf 1 m Basis Profil bei Belastung mit 1 Tonne (10.000 NT), horizontale Belastung auf der höchsten Oberfläche des Profils.

EN AW 6063
Le stress et le démenagement résultant sur la surface la plus haute de profilé de base de 1 mt à la suite d'une charge horizontale de 1000 kg.



Model Variations / Modelle / Options du modèle



Adjustable block option for not flat grounds
Einstellbares Gehäuse für unebene Böden
Option de bloc réglable pour un terrain accidenté

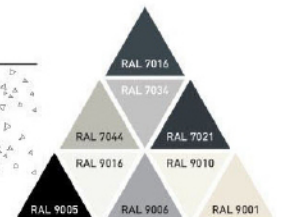
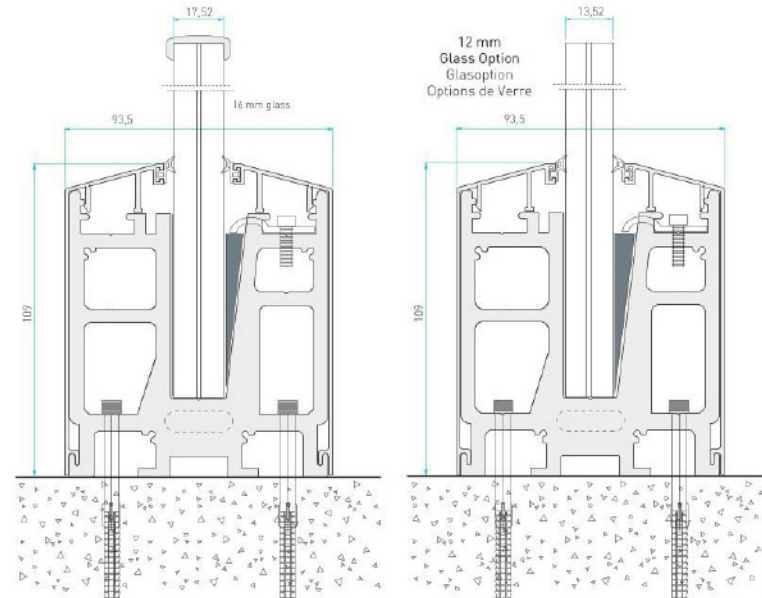



ELEGANT SERIES **C50::LED::**

C50::LED::

System zur Befestigung auf dem Boden
Système Connecté Au Sol

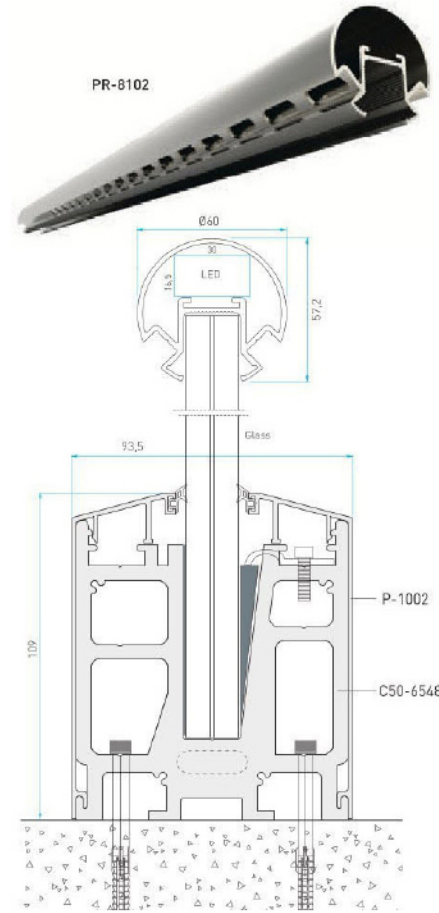

AK-8102D



AK-5190



AK-5189



AK-8102B



::LED::

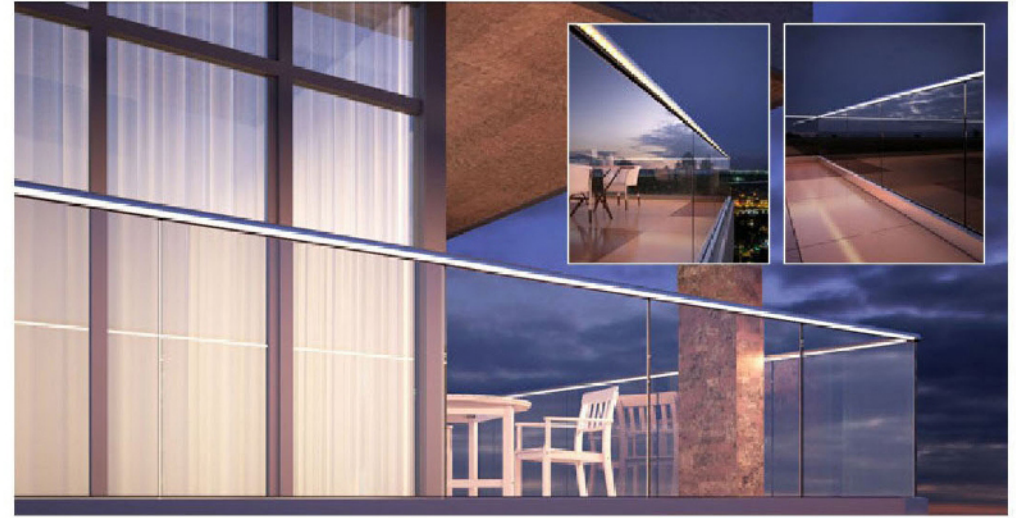

::LED::

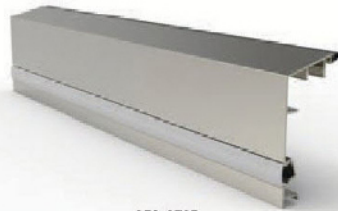
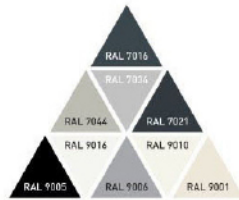
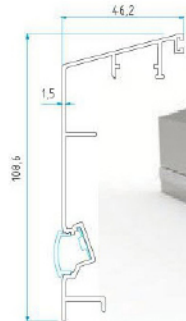
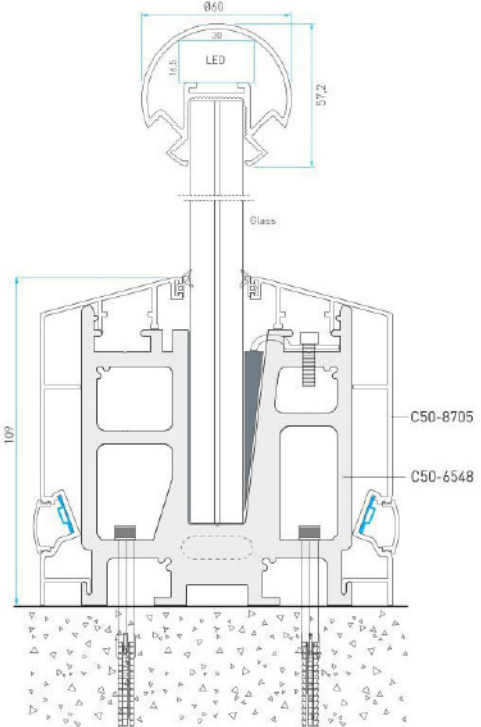
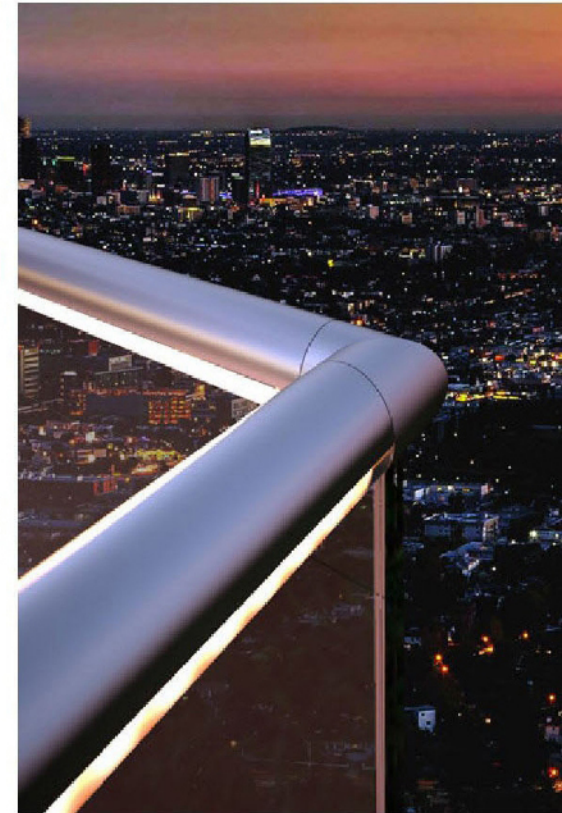



C50+

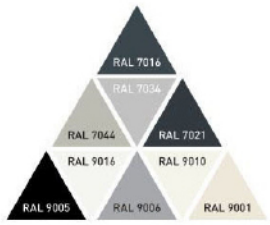
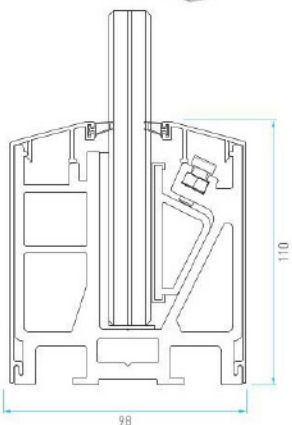

C50+

System zur Befestigung auf dem Boden / Système Connecté Au Sol

Glass Support Base Shoes



Gaskets

Glass Thickness		C50+	
10 mm	Interior Gasket	CNT-029	
	Outer Gasket	CNT-025	
12 mm (13,76 mm)	Interior Gasket	CNT-026	
	Outer Gasket	CNT025	
16 mm (17,52 mm)	Interior Gasket	CNT025	
	Outer Gasket	CNT-025	
20 mm (21,52 mm)	Interior Gasket	CNT-025	
	Outer Gasket	CNT-025	

* Exam gaskets are sold on a box basis.

Full Length Base Channel Profile

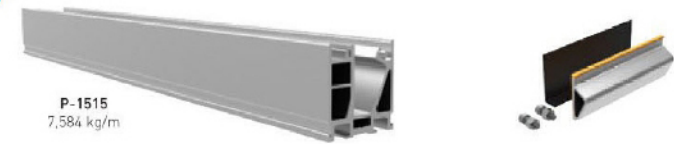

P-1515
7,584 kg/m

C50P-KMS12 Wedge set for 6+6 mm Glass
C50P-KMS16 Wedge set for 8+8 mm Glass
C50P-KMS20 Wedge set for 10+10 mm Glass

Code	C50P-1515	C50P-1515/30	C50P-5396	C50P-5396/30
Length	15 cm	30 cm	15 cm	30 cm
Glass Thickness	12 mm / 12,4 mm / 13,52 mm / 16,4 mm / 17,52 mm		20 mm / 21,52 mm	
Prefabricated	✓	✓	✓	✓
Glass Fixing	Included	Included	Included	Included
Spacer	Included	Included	Included	Included

Covers

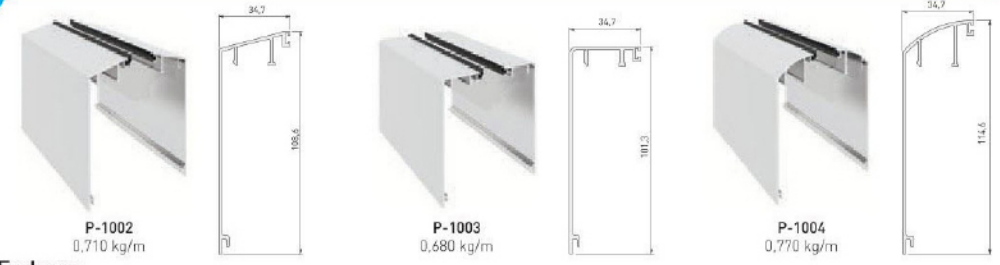

P-1002
0,710 kg/m

P-1003
0,680 kg/m

P-1004
0,770 kg/m

Endcaps



C50-1002K

C50-1003K

C50-1004K

Fixing Components



AK-5027K
Chemical Anchor

GJ10X150
M8 x 150 Threaded Rod
+ Washer + Nut

KB10X140

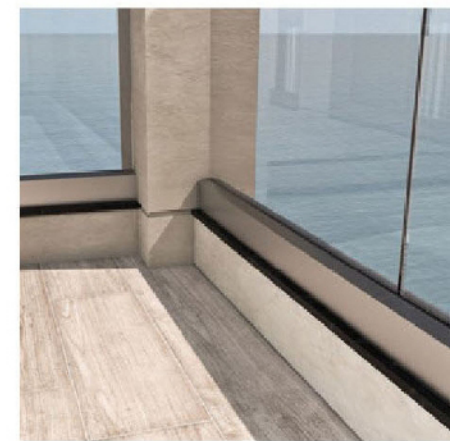



A50

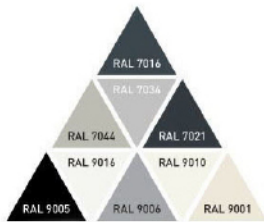
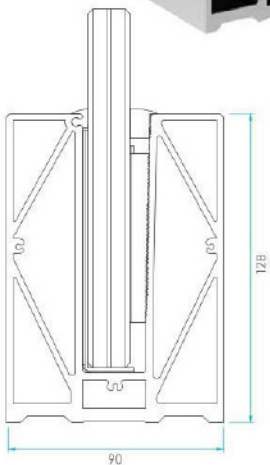

A50

System zur Befestigung auf dem Boden / Système Connecté Au Sol

Full Length Base Channel Profile

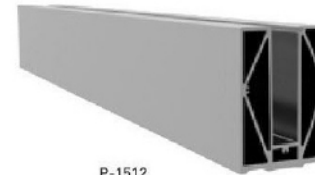

P-1512
7,53 Kg/m

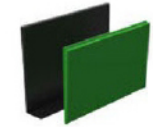

A50-KM12 (Wedge set for 6+6 mm Glass)
A50-KM16 (Wedge set for 8+8 mm Glass)
A50-KM20 (Wedge set for 10+10 mm Glass)

Code	P-1512
Length	500 cm
Weight	7,53 Kg/m
Finish	Powder Coating
Pre Drilled Holes	Upon Request
Glass Thickness	12 mm / 12,76 mm / 17,52 mm / 21,52 mm

Endcap

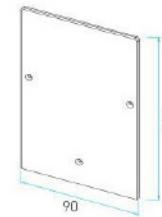

A50-1512K

Gaskets



Glass Thickness	A50	
12 mm (13,76 mm)	Interior Gasket	CNT-02
	Outer Gasket	CNT-05
16 mm (17,52 mm)	Interior Gasket	CNT-02
	Outer Gasket	CNT-01
20 mm (21,52 mm)	Interior Gasket	CNT-022
	Outer Gasket	CNT-01

* Epdm gaskets are sold on a box basis.



Fixing Components



AK-5027K
Chemical Anchor



GJ10x150
M10 x 150 Threaded Rod
+ Washer + Nut



AK-5299
Wedge Fixing Tool



Installation Details

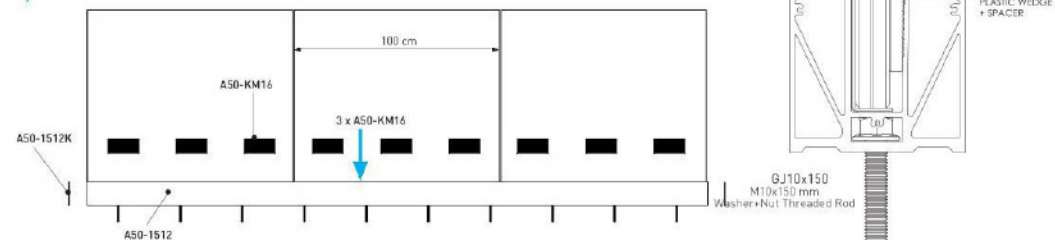



U50

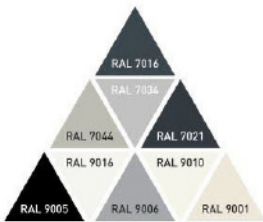
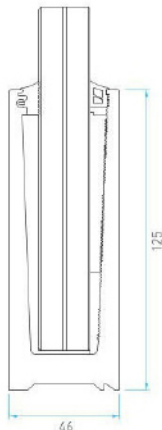

U50

System zur Befestigung auf dem Boden / Système Connecté Au Sol

Full Length Base Channel Profile

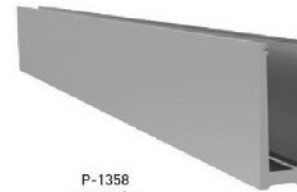

P-1358
5,83 Kg/m

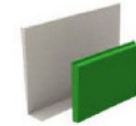

U50-KM12 (Wedge set for 6+6 mm Glass)
U50-KM16 (Wedge set for 8+8 mm Glass)
U50-KM20 (Wedge set for 10+10 mm Glass)

Code	P-1358
Length	600 cm
Weight	5,83 Kg/m
Finish	Natural Anodize / Powder Coating
Pre Drilled Holes	Upon Request
Glass Thickness	12 mm / 12,76 mm / 17,52 mm / 21,52 mm

Gaskets



Glass Thickness		U50
16 mm (17,52 mm)	Interior Gasket	CNT-09
	Outer Gasket	CNT-08
20 mm (21,52 mm)	Interior Gasket	CNT-010
	Outer Gasket	CNT-08

• Epdm gaskets are sold on a box basis.

Endcap



U50-1358K



Fixing Components



VJ10X140
Universal Anchor



AK-5299
Wedge Fixing Tool





U50F

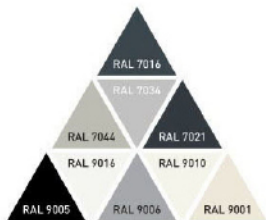
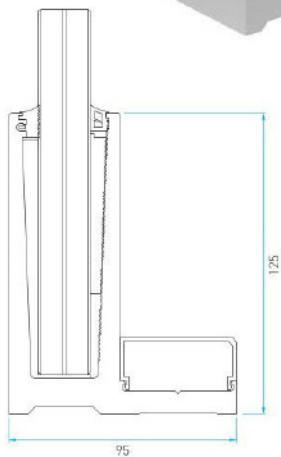

U50F

System zur Befestigung auf dem Boden / Système Connecté Au Sol

Full Length Base Channel Profile



P-1519
7,14 Kg/m

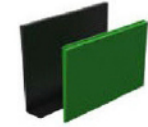

U50-KM12 (Wedge set for 6+6 mm Glass)
U50-KM16 (Wedge set for 8-8 mm Glass)
U50-KM20 (Wedge set for 10+10 mm Glass)

Code	P-1519
Length	600 cm
Weight	7,14 Kg/m
Finish	Natural Anodize / Powder Coating
Pre Drilled Holes	Upon Request
Glass Thickness	12 mm / 12,76 mm / 17,52 mm / 21,52 mm

Gaskets



Glass Thickness		U50F
16 mm (17,52 mm)	Interior Gasket	CNT-09
	Outer Gasket	CNT-08
20 mm (21,52 mm)	Interior Gasket	CNT-010
	Outer Gasket	CNT-08

* Eppim gaskets are sold on a box basis.

Cover



P-1345
0,436 Kg/m

Endcap

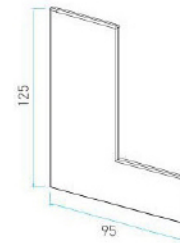

U50F-1519K

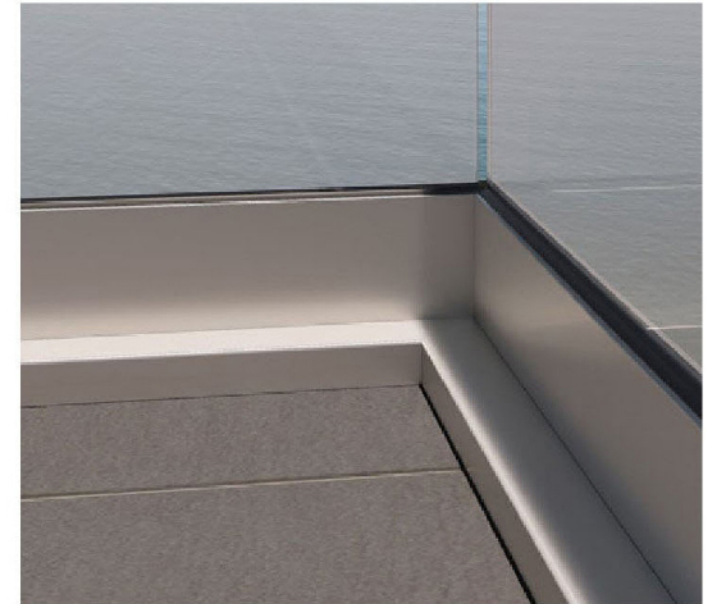

Fixing Components



AK-5027K
Chemical Anchor



GJ10X150
M10 x 100 Threaded Rod
+ Washer + Nut



VJ10X140
Universal Anchor



AK-5299
Wedge Fixing Tool





U50Max

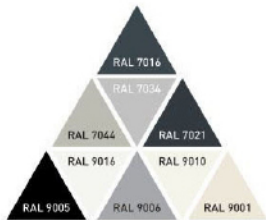
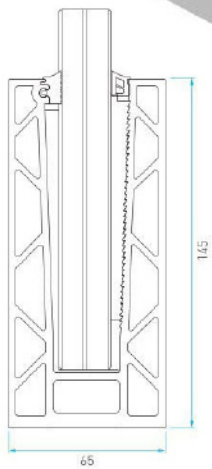

U50Max

System zur Befestigung auf dem Boden / Système Connecté Au Sol

Full Length Base Channel Profile

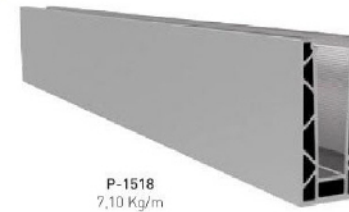

P-1518
7,10 Kg/m

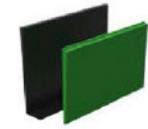

U50M-KM12 (Wedge set for 6+6 mm Glass)
U50M-KM16 (Wedge set for 8+8 mm Glass)
U50M-KM20 (Wedge set for 10+10 mm Glass)

Code	P-1518
Length	600 cm
Weight	7,10 Kg/m
Finish	Natural Anodize / Powder Coating
Pre Drilled Holes	Upon Request
Glass Thickness	12 mm / 12,76 mm / 17,52 mm / 21,52 mm

Gaskets



Glass Thickness		U50 Max
16 mm (17,52 mm)	Interior Gasket	CNT-09
	Outer Gasket	CNT-08
20 mm (21,52 mm)	Interior Gasket	CNT-010
	Outer Gasket	CNT-08

* Edcm gaskets are sold on a box basis.

Endcap

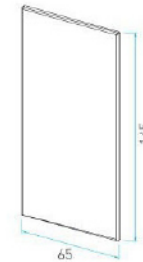

U50M-1518K



Fixing Components



AK-5027K
Chemical Anchor



GJ10X150
M10 x 100 Threaded Rod
+ Washer + Nut



KB10X140



AK-5299
Wedge Fixing Tool

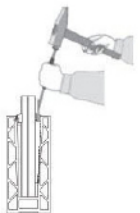



U50F^{Max}

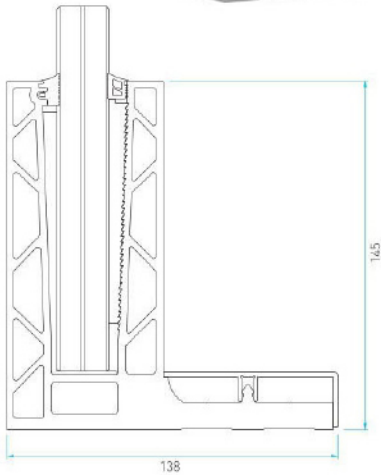

U50F^{Max} System zur Befestigung auf dem Boden / Système Connecté Au Sol

Full Length Base Channel Profile



P-1522
9,84 Kg/m

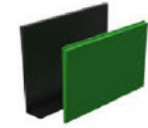

U50M-KM12 (Wedge for 6+6 mm Glass)
U50M-KM16 (Wedge for 8+8 mm Glass)
U50M-KM20 (Wedge for 10+10 mm Glass)

Code	P-1522
Length	400 cm
Weight	9,84 Kg/m
Finish	Natural Anodize / Powder Coating
Pre Drilled Holes	Upon Request
Glass Thickness	12 mm / 12,75 mm / 17,52 mm / 21,52 mm

Gaskets



Glass Thickness		U50F Max
16 mm (17,52 mm)	Interior Gasket	CNT-09
	Outer Gasket	CNT-08
20 mm (21,52 mm)	Interior Gasket	CNT-010
	Outer Gasket	CNT-08

• Epdm gaskets are sold on a box basis.

Cover



P-AL7405
0,620 Kg/m

Endcap

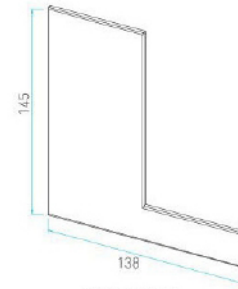

U50FM-1522K

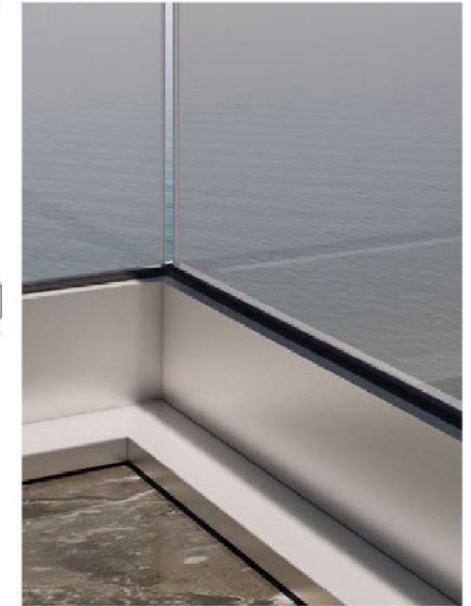
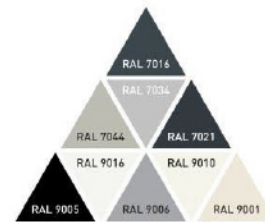

Fixing Components



AK-5027K
Chemical Anchor



GJ10X10 0
M10 x 100 Threaded Rod
+ Washer + Nut



KB10X140



AK-5299
Wedge Fixing Tool

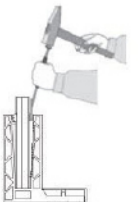



U50R^{Max}



U50R^{Max} System zur Befestigung auf dem Boden / Système Connecté Au Sol

Full Length Base Channel Profile

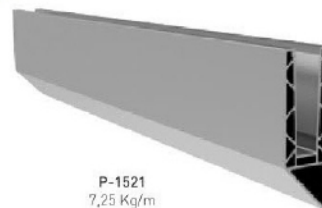

P-1521
7,25 Kg/m

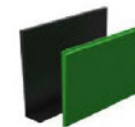

U50M-KM12 | Wedge set for 6+6 mm Glass
U50M-KM16 | Wedge set for 8+8 mm Glass
U50M-KM20 | Wedge set for 10+10 mm Glass

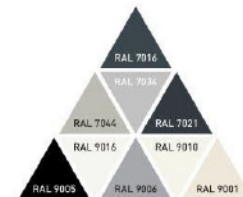

Code	P-1521
Length	600 cm
Weight	7,25 Kg/m
Finish	Mill Finish
Pre Drilled Holes	Upon Request
Glass Thickness	12 mm / 12,76 mm / 17,52 mm / 21,52 mm

Gaskets



Glass Thickness		U50R Max
16 mm (17,52 mm)	Interior Gasket	CNT-29
	Outer Gasket	CNT-025
20 mm (21,52 mm)	Interior Gasket	CNT-026
	Outer Gasket	CNT-025

* Epdm gaskets are sold on a box basis.

Cover



P-1520
1,45 Kg/m



P-AL9205
0,140 Kg/m

Endcap



U50RM-1521K

Installation Details

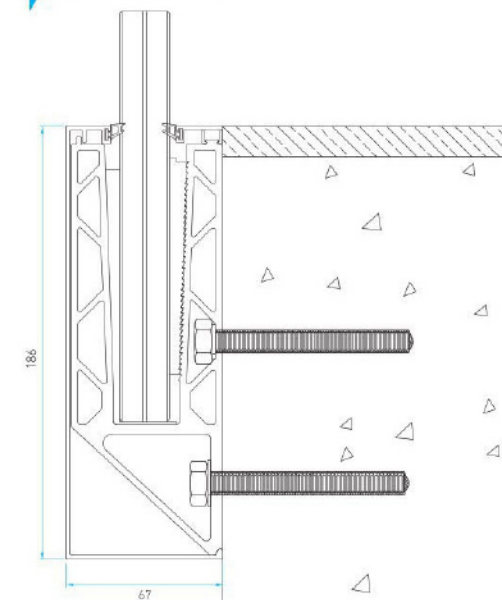

Fixing Components



AK-5027K
Chemical Anchor



GJ10X10 0
M10 x 100 Threaded Rod
+ Washer + Nut



AK-5299
Wedge Fixing Tool

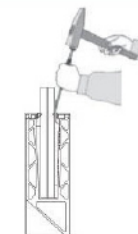



EX50

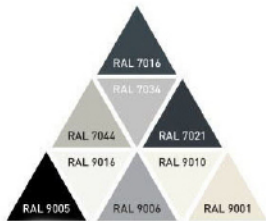
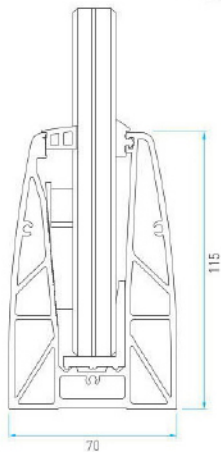

EX50

System zur Befestigung auf dem Boden / Système Connecté Au Sol

Full Length Base Channel Profile

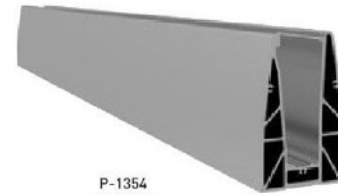

P-1354
4,50 Kg/m

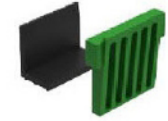

EX50-KM12 (Wedge set for 6+6 mm Glass)
EX50-KM16 (Wedge set for 8+8 mm Glass)
EX50-KM20 (Wedge set for 10+10 mm Glass)

Code	P-1354
Length	500 cm
Weight	4,50 Kg/m
Finish	Natural Anodize / Powder Coating
Pre Drilled Holes	Upon Request
Glass Thickness	12 mm / 12,76 mm / 17,52 mm / 21,52 mm

Gaskets



Glass Thickness		EX50
16 mm (17,52 mm)	Interior Gasket	CNT-09
	Outer Gasket	CNT-019
20 mm (21,52 mm)	Interior Gasket	CNT-010
	Outer Gasket	CNT-019

* Epdm gaskets are sold on a box basis.

Endcap

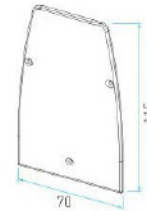

EX50-1354K

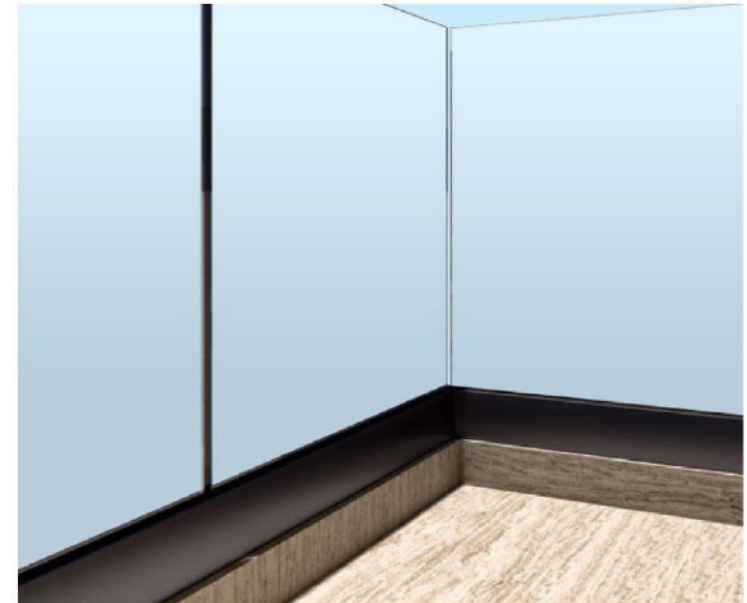

Fixing Components



AK-5027K
Chemical Anchor



GJ10X150
M10 x 100 Threaded Rod
+ Washer + Nut



KB10X140



AK-5299
Wedge Fixing Tool





X50

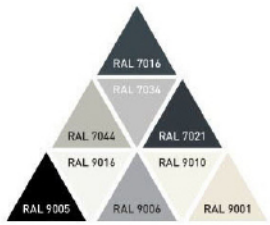
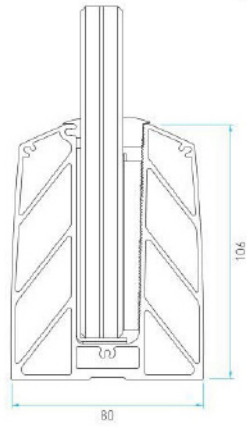

X50

System zur Befestigung auf dem Boden / Système Connecté Au Sol

Full Length Base Channel Profile

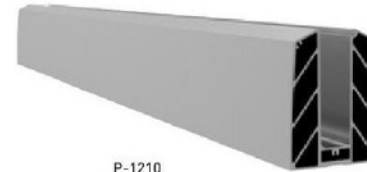

P-1210
4,22 Kg/m

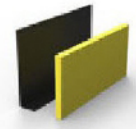

X50-KM10 (Wedge set for 5+5 mm Glass)
X50-KM12 (Wedge set for 6+6 mm Glass)
X50-KM16 (Wedge set for 8+8 mm Glass)

Code	X50-1210
Length	500 cm
Weight	4,22 Kg/m
Finish	Powder Coating / Natural Anodize / Inox Anodize
Pre Drilled Holes	Upon Request
Glass Thickness	10 mm / 12 mm / 12,76 mm / 17,52 mm

Gaskets



Glass Thickness	Interior Gasket	X50
10 mm	Outer Gasket	CNT-02
12 mm (13,76 mm)	Interior Gasket	CNT-02
	Outer Gasket	CNT-05
16 mm (17,52 mm)	Interior Gasket	CNT-02
	Outer Gasket	CNT-01

• Epdm gaskets are sold on a box basis.

Endcap

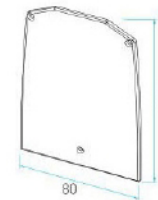

X50-1210K



Fixing Components



AK-5027K
Chemical Anchor



GJ8X10 0
M10 x 100 Threaded Rod
+ Washer + Nut



KB10X140



AK-5299
Wedge Fixing Tool

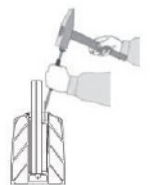



N50S

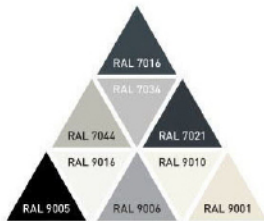
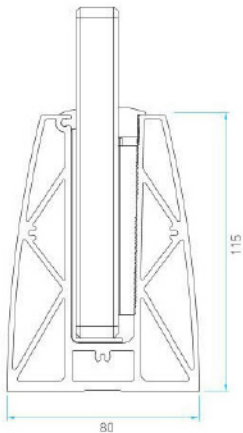

N50S

System zur Befestigung auf dem Boden / Système Connecté Au Sol

Full Length Base Channel Profile

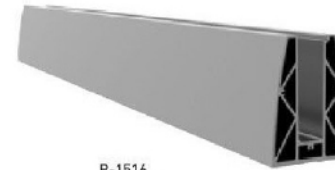

P-1516
5,45 Kg/m

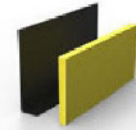

N50-KM10 (Wedge set for 5+5 mm Glass)
N50-KM12 (Wedge set for 6+6 mm Glass)
N50-KM16 (Wedge set for 8+8 mm Glass)
N50-KM20 (Wedge set for 10+10 mm Glass)

Code	P-1516
Length	600 cm
Weight	5,45 Kg/m
Finish	Natural Anodize / Powder Coating
Pre Drilled Holes	Upon Request
Glass Thickness	10 mm / 12 mm / 12,76 mm / 17,52 mm / 21,52 mm

Gaskets



Glass Thickness	Interior Gasket	N50S
10 mm	Interior Gasket	CNT-02
	Outer Gasket	CNT-06
12 mm (13,76 mm)	Interior Gasket	CNT-02
	Outer Gasket	CNT-05
16 mm (17,52 mm)	Interior Gasket	CNT-02
	Outer Gasket	CNT-01
20 mm (21,52 mm)	Interior Gasket	CNT-022
	Outer Gasket	CNT-01

* Epdm gaskets are sold on a box basis.

Endcap

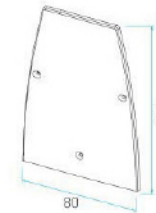

N50S-1516K



Fixing Components



AK-5027K
Chemical Anchor



GJ10X150
M10 x 100 Threaded Rod
+ Washer + Nut



AK-5299
Wedge Fixing Tool





N50

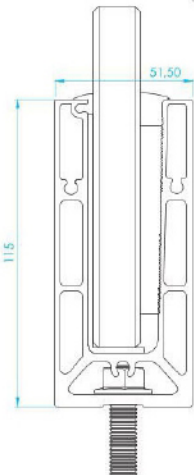

Optional Prefabricated Water Drainage Canals

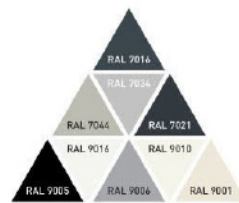
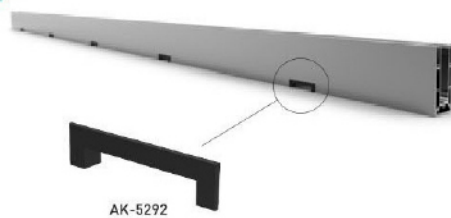

N50

System zur Befestigung auf dem Boden / Système Connecté Au Sol



Full Length Base Channel Profile

Code	P-1024
Length	500 cm
Finishing	Natural Anodize / Powder Coating
Glass Thickness	10,76mm/12,76mm/16,76mm/17,52mm/21,52mm
Prefabricated	Upon Request
Plastic Wedge+Spacer	X
Gaskets	X

P-1024
 4,50 kg/m
 (N50-8984)

N50-KM10 (Wedge set for 5+5 mm Glass)
N50-KM12 (Wedge set for 6+6 mm Glass)
N50-KM16 (Wedge set for 8+8 mm Glass)
N50-KM20 (Wedge set for 10+10 mm Glass)

Endcaps



Gaskets



Glass Thickness	Interior Gasket	N50
10 mm	Outer Gasket	CNT-02
12 mm (13,76 mm)	Outer Gasket	CNT-06
16 mm (17,52 mm)	Interior Gasket	CNT-05
16 mm (17,52 mm)	Outer Gasket	CNT-02
20 mm	Interior Gasket	CNT-022
20 mm (21,52 mm)	Outer Gasket	CNT-01

* Epdm gaskets are sold on a box basis.

Fixing Components



AK-5027K
Chemical Anchor



GJ10X150
M10 x 150 Threaded Rod + Washer + Nut



AK-5299
Wedge Fixing Tool

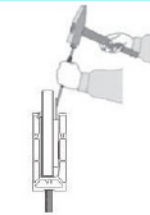

Installation Details

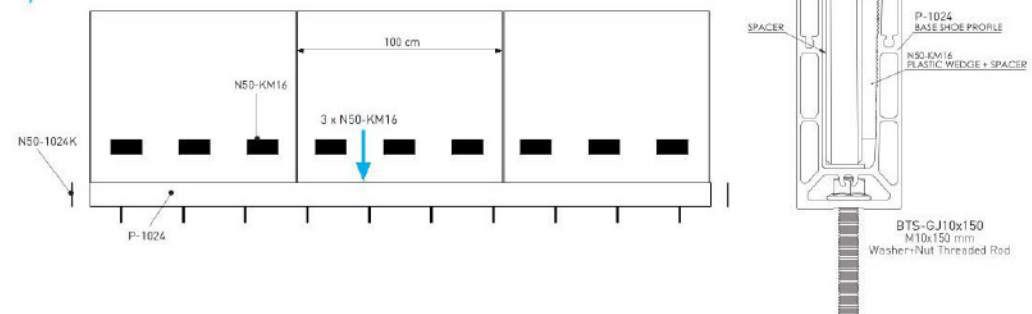

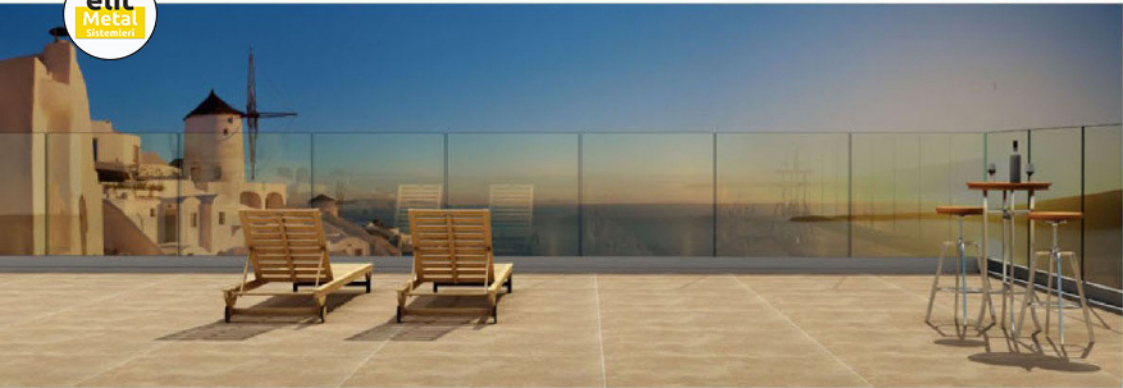

N50F

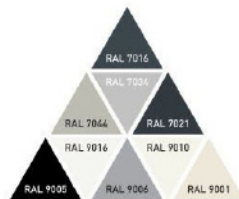
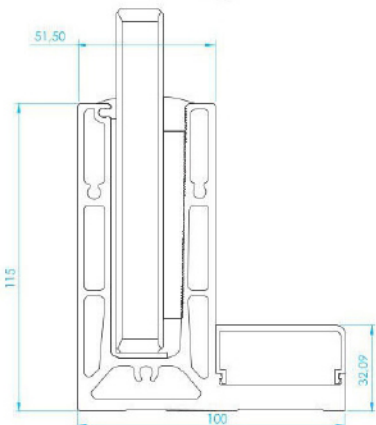

N50F

System zur Betestigung auf dem Boden / Système Connecté Au Sol

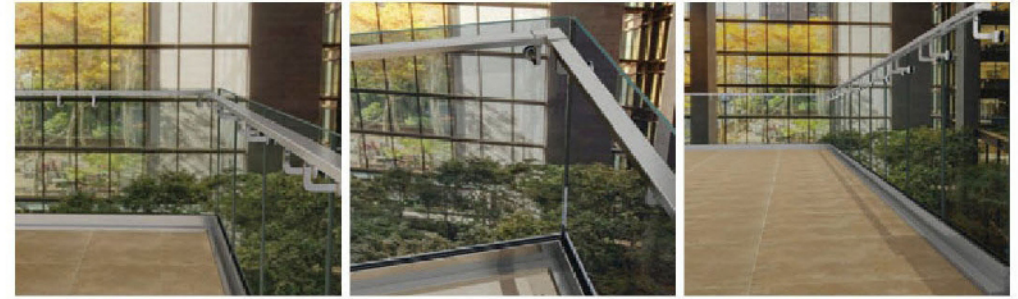

Full Length Base Channel Profile



P-1025
5,70 kg/m
(N50F-1952)

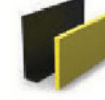

N50-KM10 (Wedge set for 5+5 mm Glass)
N50-KM12 (Wedge set for 6+6 mm Glass)
N50-KM16 (Wedge set for 8+8 mm Glass)
N50-KM20 (Wedge set for 10+10 mm Glass)

Code	P-1025
Length	500 cm
Finishing	Natural Anodize / Powder Coating
Glass Thickness	10,76mm/12,76mm/16,76mm/17,52mm/21,52mm
Prefabricated	Upon Request
Plastic Wedge+Spacer	X
Gaskets	X

Covers



P-1345
0,436 kg/m
(N50F-1953)

Endcaps



N50F-1025K

Gaskets



Glass Thickness		N50F
10 mm	Interior Gasket	CNT-02
	Outer Gasket	CNT-06
12 mm (13,76 mm)	Interior Gasket	CNT-02
	Outer Gasket	CNT-05
16 mm (17,52 mm)	Interior Gasket	CNT-02
	Outer Gasket	CNT-01
20 mm (21,52 mm)	Interior Gasket	CNT-022
	Outer Gasket	CNT-01

* Epdm gaskets are sold on a box basis.

Fixing Components



AK-5027K
Chemical Anchor



GJ10X150
M10 x 150 Threaded Rod + Washer + Nut



AK-5299
Wedge Fixing Tool

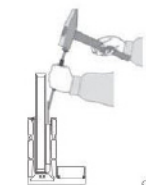

EPDM RUBBER GASKET

Installation Details

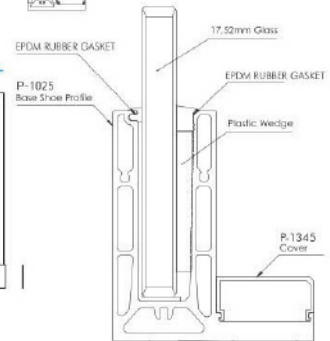
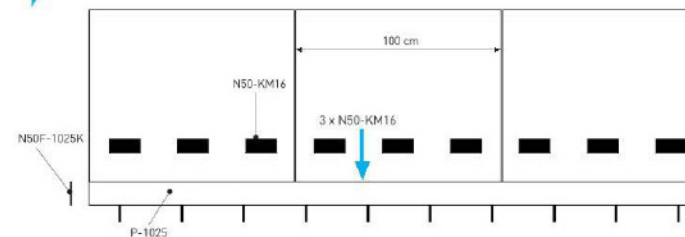

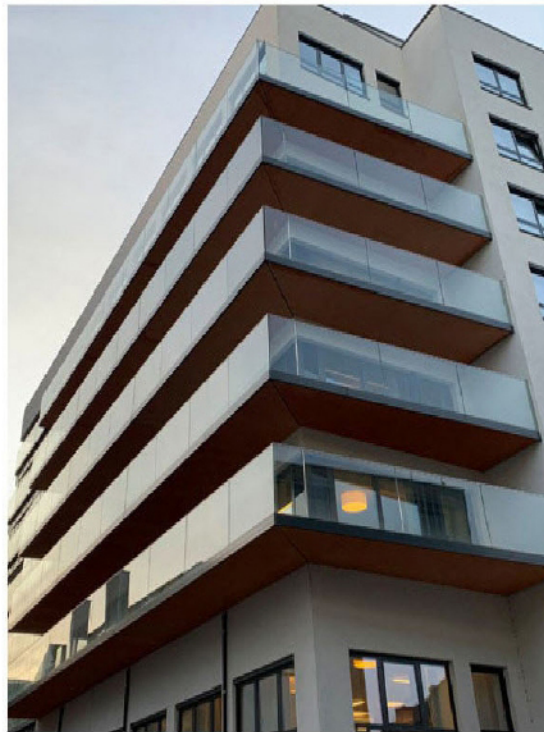

N50R

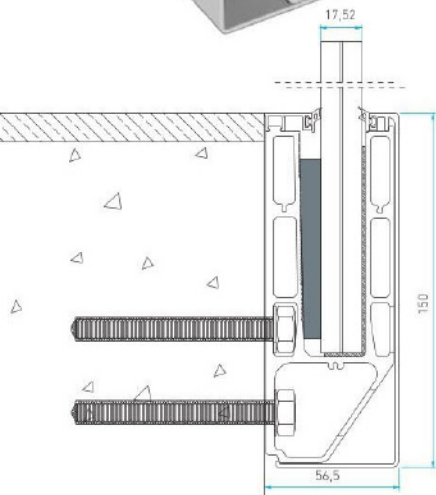

N50R

Seitliches Verbindungssystem
Système de Connexion Latérale

Full Length Base Channel Profile

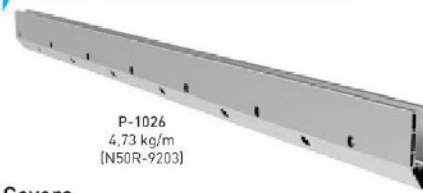

P-1026
4,73 kg/m
(N50R-9203)

Code	P-1026
Length	500 cm
Finishing	Mill Finish
Glass Thickness	12,76 mm / 16,76 mm / 17,52 mm / 21,52 mm
Prefabricated	Upon Request
Plastic Wedge+Spacer	X
Baskets	X

Covers



P-AL9204
0,947 Kg/m



P-AL9205
0,140 Kg/m

Endcaps



N50R-1026K

Wedges & Spacer

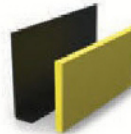

- N50-KM10 (Wedge set for 5+5 mm Glass)
- N50-KM12 (Wedge set for 6+6 mm Glass)
- N50-KM16 (Wedge set for 8+8 mm Glass)
- N50-KM20 (Wedge set for 10+10 mm Glass)

Gaskets



Glass Thickness	Interior Gasket	N50R
10 mm	Interior Gasket	CNT-029
	Outer Gasket	CNT-029
12 mm (13,76 mm)	Interior Gasket	CNT-029
	Outer Gasket	CNT-026
16 mm (17,52 mm)	Interior Gasket	CNT-029
	Outer Gasket	CNT-025
20 mm (21,52 mm)	Interior Gasket	CNT-025
	Outer Gasket	CNT-025

• Epdm gaskets are sold on a box basis.

Fixing Components



AK-5027K
Chemical Anchor



GJ10X150
M10 x 150 Threaded Rod + Washer + Nut



AK-5299
Wedge Fixing Tool

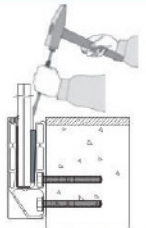

Installation Details

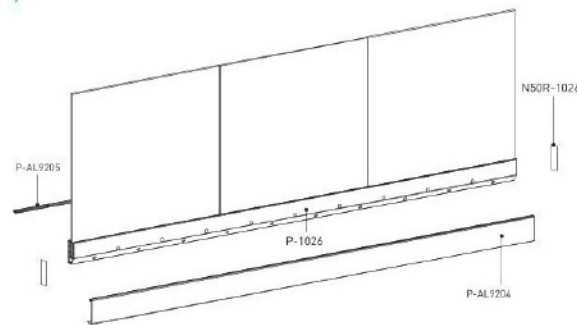



C70

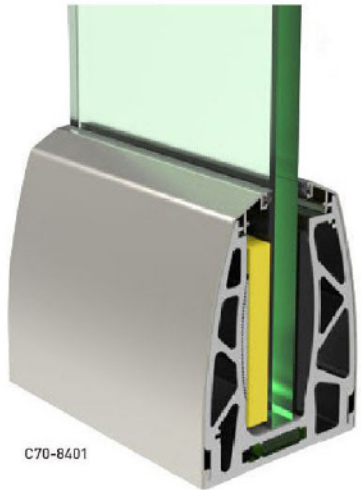

C70-8401

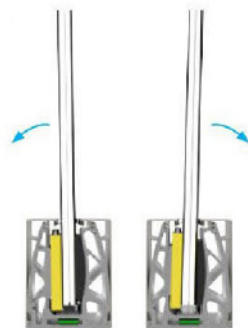
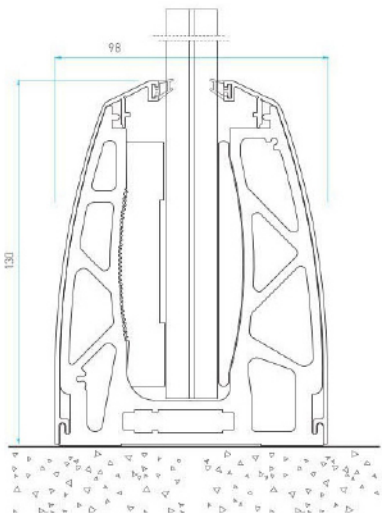

C70

System zur Befestigung auf dem Boden mit Glaswinkeleinstellung
Reglable garde corps en verre sur sol

Glass Support Base Shoes



C70-8401

C70-8401/30

- Material List**
- 1- Glass support base shoe
 - 2- Magic pack
 - 3- Bubble level
 - 4- Adjusting wedge

Gaskets



Glass Thickness		C70
16 mm (17,52 mm)	Interior Gasket	CNT-023GK
	Outer Gasket	CNT-023GK

* Epdm gaskets are sold on a box basis.

Full Length Base Channel Profile



C70-8401/3M

C70-MP16
Magic pack set for 8-8 mm Glass

Code	C70-8401	C70-8401/30	C70-8401/3M
Length	15 cm	30 cm	300 cm
Glass Thickness	16,4 mm / 17,52 mm Glass		
Prefabricated	✓	✓	Upon Request
Magic Pack	Included	Included	✗

Covers

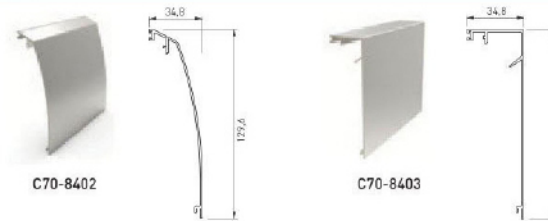

C70-8402

C70-8403

Endcaps



C70-8402K

C70-8403K

Fixing Components



AK-5027K
Chemical anchor

GJ10X150
M10 x 150 Threaded rod + Washer + Nut



Installation Details

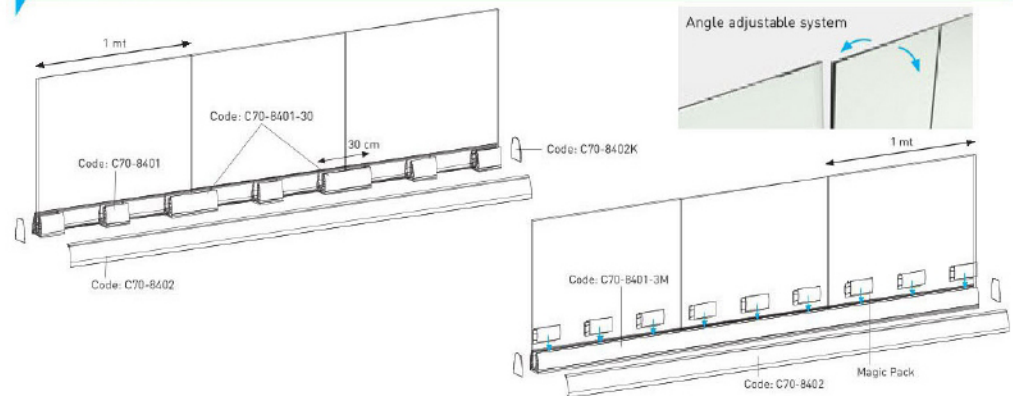



C60

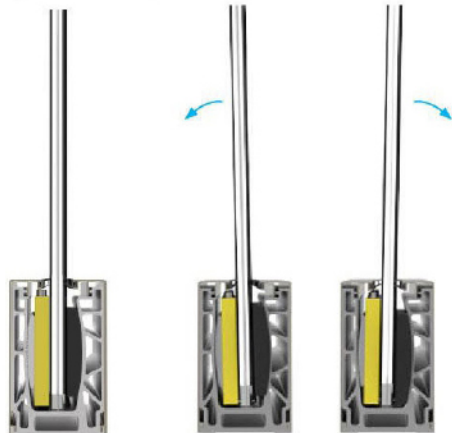
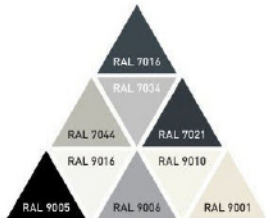
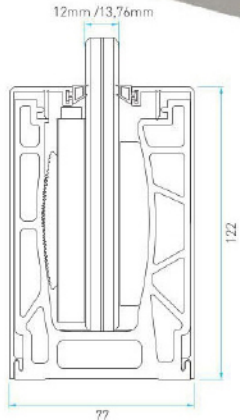

C60

System zur Befestigung auf dem Boden / Système Connecté Au Sol

Glass Support Base Shoes



C60-1008

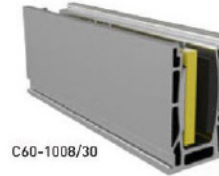

C60-1008/30



C60-MP

Gaskets



Glass Thickness	C60	
12 mm (13,76 mm)	Interior Gasket	CNT-023GK
	Outer Gasket	CNT-023GK

* Epdm gaskets are sold on a box basis.

Full Length Base Channel Profile

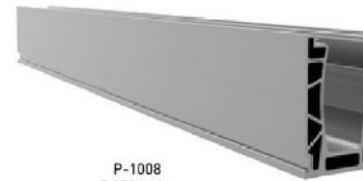

P-1008
5,852 kg/m

Endcap

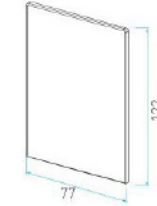

C60-1008K



P-1009
0,776 kg/m

Cover

Code	C60-1008	C60-1008/30
Length	15 cm	30 cm
Glass Thickness	12 mm / 13,52 mm	
Prefabricated	✓	✓
Magic Pack	Included	Included
Spacer	Included	Included

Angle adjustable system

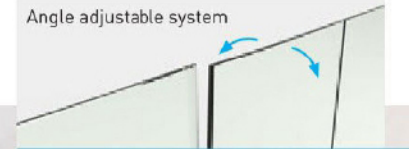

Fixing Components



AK-5027K
Chemical Anchor



GJ10X150
M10 x 100 Threaded Rod
+ Washer + Nut



KB10X140



AK-5299
Wedge Fixing Tool

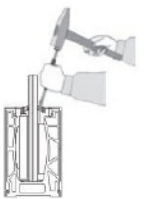



AS55

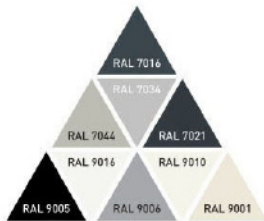
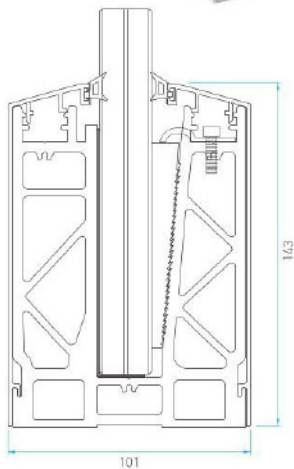

AS55

System zur Befestigung auf dem Boden / Système Connecté Au Sol

Glass Support Base Shoes

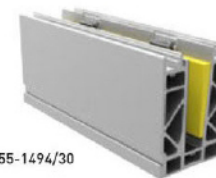

Gaskets



Glass Thickness		AS55	
16 mm (17,52 mm)	Interior Gasket	CNT-029	
	Outer Gasket	CNT-025	
20 mm (21,52 mm)	Interior Gasket	CNT-026	
	Outer Gasket	CNT-025	

* Epdm gaskets are sold on a box basis.

Full Length Base Channel Profile

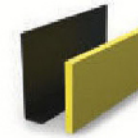
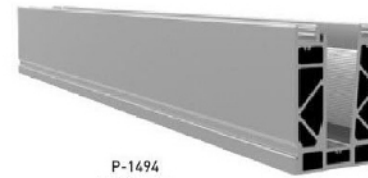

Code	AS55-1494	AS55-1494/30	AS55-5397	AS55-5397/30
Length	15 cm	30 cm	15 cm	30 cm
Glass Thickness	16,4 mm / 17,52 mm		20 mm / 21,52 mm	
Prefabricated	✓	✓	✓	✓
Plastic Wedge	Included	Included	Included	Included
Spacer	Included	Included	Included	Included

Endcap

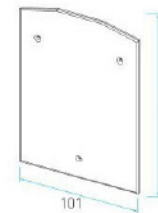

Cover

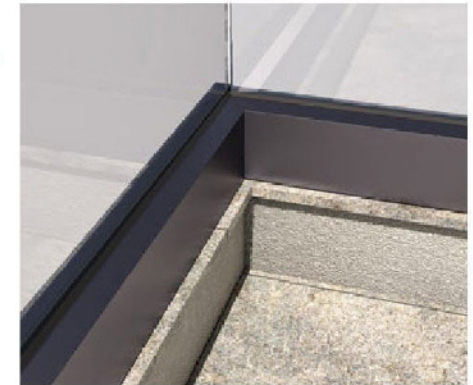

Fixing Components

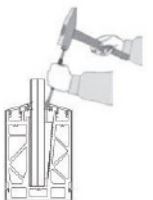



R50^{Neo}

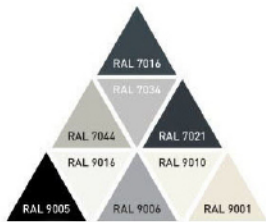
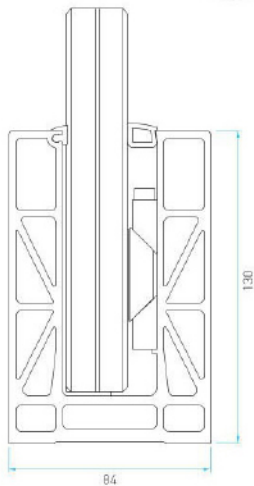

R50^{Neo}

System zur Befestigung auf dem Boden / Système Connecté Au Sol

Full Length Base Channel Profile

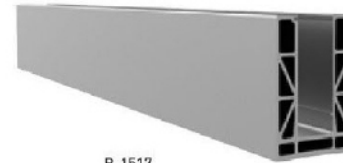

P-1517
8,23 Kg/m



R50N-KM20 (Aluminium fixing tool for 21,52 mm glass + Spacer)
R50N-KM25 (Aluminium fixing tool for 25,52 mm glass + Spacer)

Code	P-1517
Length	500 cm
Weight	8,23 Kg/m
Finish	Natural Anodize / Powder Coating
Pre Drilled Holes	Upon Request
Glass Thickness	21,52 mm / 25,52 mm

Gaskets



Glass Thickness		R50 Neo
20 mm (21,52 mm)	Interior Gasket	CNT-02
	Outer Gasket	CNT-035
25 mm (25,52 mm)	Interior Gasket	CNT-02
	Outer Gasket	CNT-01

* Epdm gaskets are sold on a box basis.

Endcap

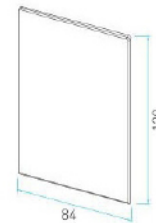

R50N-1517K



Fixing Components



AK-5027K
Chemical Anchor



GJ10X150
M10 x 100 Threaded Rod
+ Washer + Nut



AK-5299
Wedge Fixing Tool

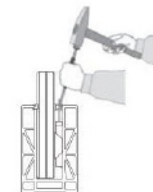



FX50

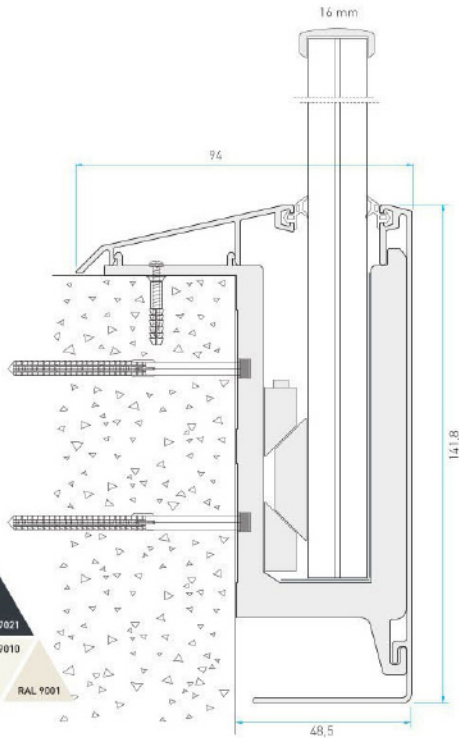
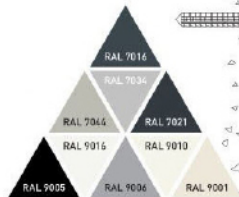

FX50

Seitliches Verbindungssystem / Système de Connexion Latérale

Full Length Base Channel Profile



FX50-6770
200 cm



BTS-LP1
2 x Spacer is Included



8 x Pressing Tool is Included

Covers



FX50-6772



Inner Cover for
17,52 mm Glass



FX50-7598



Inner Cover for
13,52 mm Glass



FX50-6771
External Cover



Endcaps



FX50-6770K



Fixing Components



KB10X140

Gaskets



Glass Thickness	FX50	
12 mm (13,76 mm)	Interior Gasket	CNT-026
	Outer Gasket	CNT-025
16 mm (17,52 mm)	Interior Gasket	CNT-026
	Outer Gasket	CNT-025
20 mm (21,52 mm)	Interior Gasket	CNT-025
	Outer Gasket	CNT-025

* Epcim gaskets are sold on a box basis.

Installation Details

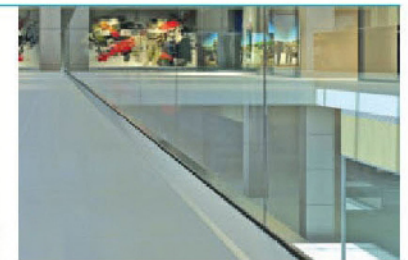



NX50

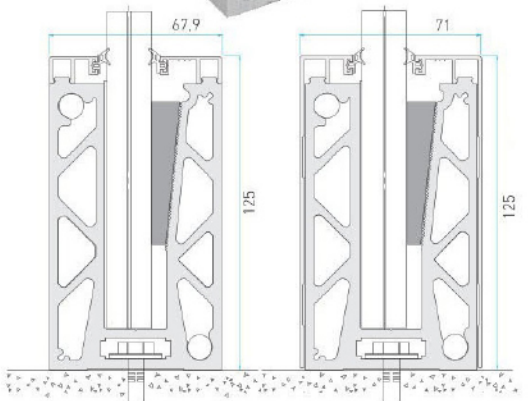
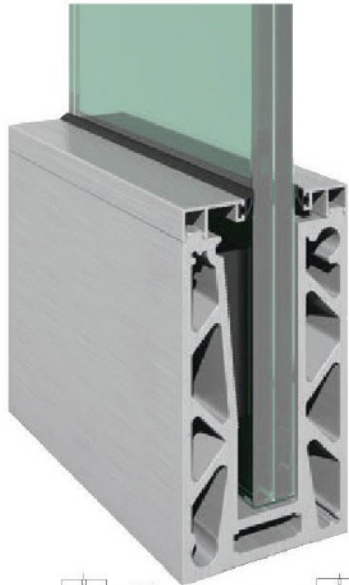

NX50

System zur Befestigung auf dem Boden / Système Connecté Au Sol

Glass Support Base Shoes



- Material List**
- 1- Glass support base shoe
 - 2- Spacer
 - 3- Plastic wedge

Full Length Base Channel Profile

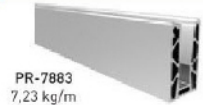

PR-7883
7,23 kg/m

Code	NX50-7883	NX50-7883/30	NX50-5320	NX50-5320/30	PR-7883
Length	15 cm	30 cm	15 cm	30 cm	300 cm
Glass Thickness	16,4 mm / 17,52 mm Glass		20,4 mm / 21,52 mm Glass		16,4 mm / 17,52 mm Glass 20,4 mm / 21,52 mm Glass
Prefabricated	✓	✓	✓	✓	Upon Request
Plastic Wedge + Spacer	Included	Included	Included	Included	X

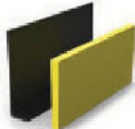

NX50-KMS16 (8+8 mm Glass)
NX50-KMS20 (10+10 mm Glass)

Covers



NX50-7884



NX50-7885

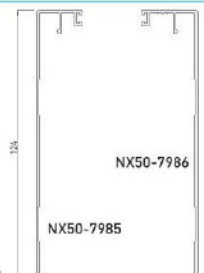

NX50-7985

Endcaps



NX50-7884K



NX50-7985K

Connector Pin



NX50-7883PM

Connection of NX50-7883 Base Profile



Fixing Components



AK-5027K
Chemical Anchor



KB10X140



GJ10X150
M10 x 150 Threaded Rod + Washer + Nut



AK-5299
Wedge Fixing Tool

Gaskets



Glass Thickness		NX50
12 mm (13,76 mm)	Interior Gasket	CNT-029
	Outer Gasket	CNT-025
16 mm (17,52 mm)	Interior Gasket	CNT-026
	Outer Gasket	CNT-025
20 mm (21,52 mm)	Interior Gasket	CNT-025
	Outer Gasket	CNT-025

• Epdm gaskets are sold on a box basis.

Installation Details

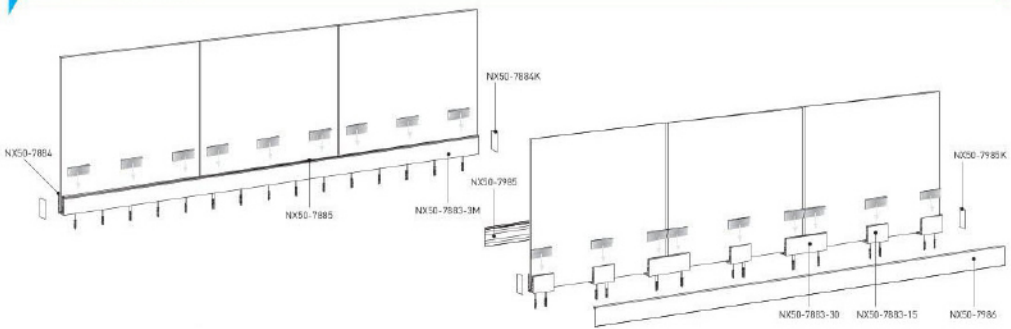

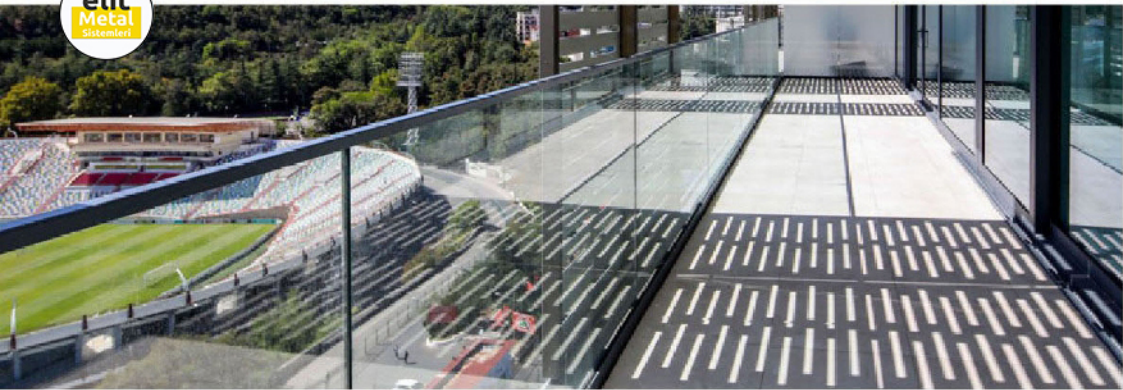

M50

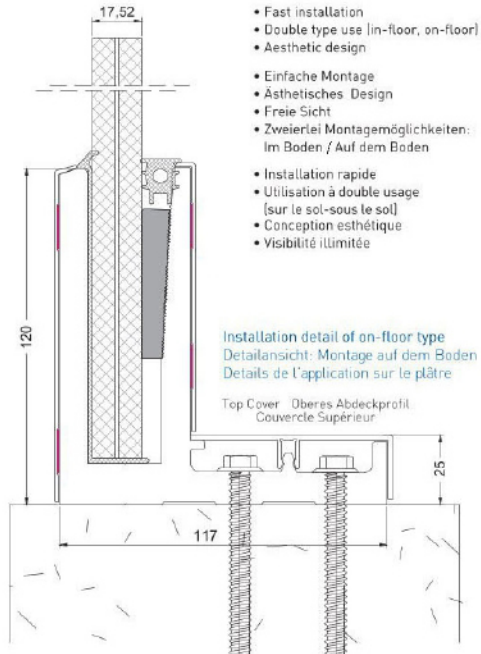
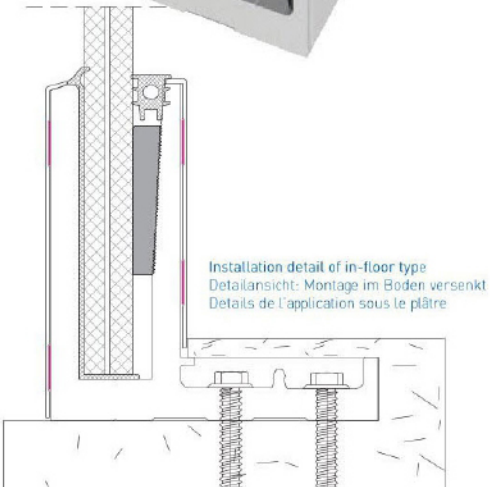

- Fast installation
- Double type use (in-floor, on-floor)
- Aesthetic design
- Einfache Montage
- Ästhetisches Design
- Freie Sicht
- Zweierlei Montagemöglichkeiten: Im Boden / Auf dem Boden
- Installation rapide
- Utilisation à double usage (sur le sol-sous le sol)
- Conception esthétique
- Visibilité illimitée

M50

Zweierlei Anwendungsmöglichkeiten / Système de Double Usage

Full Length Base Channel Profile



Code	M50-6962
Length	200 cm
Glass Thickness	16,4 mm / 17,52 mm / 21,52 mm Glass
Prefabricated	Upon Request
Spacer	X
Wedge	X



Covers

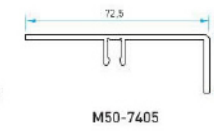
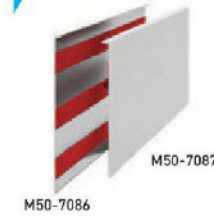

Endcaps

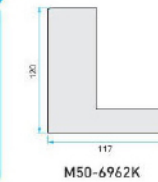

Gaskets

Glass Thickness		M50
16 mm (17,52 mm)	Interior Gasket	CNT-020
20 mm (21,52 mm)	Interior Gasket	CNT-021

• Epidm gaskets are sold on a box basis.

Fixing Components



Installation Details

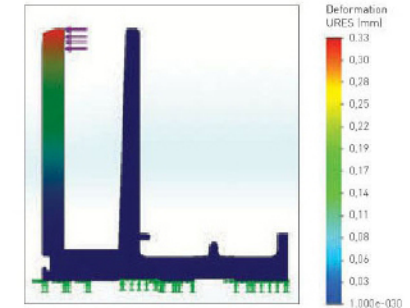
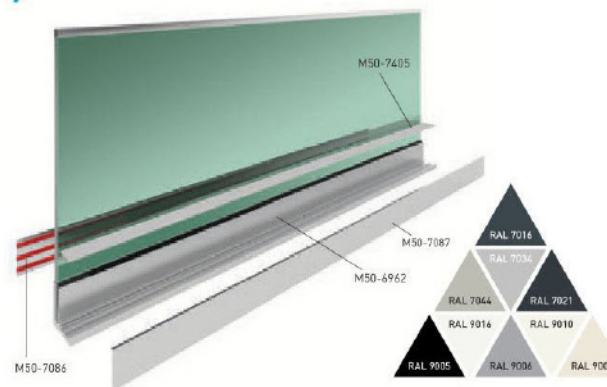

Alloy EN AW 6063
Stress and relocation results on 1mt base profile with 500 kg horizontal load to the highest surface of the profile.

Belastungs- und Verlagerungsergebnisse auf 1 m Basis Profil bei Belastung mit 500 kg, horizontale Belastung auf der höchsten Oberfläche des Profils.

EN AW 6063
Le stress et le déménagement résultant sur la surface la plus haute de profilé de base de 1 mt à la suite d'une charge horizontale de 500 kg.

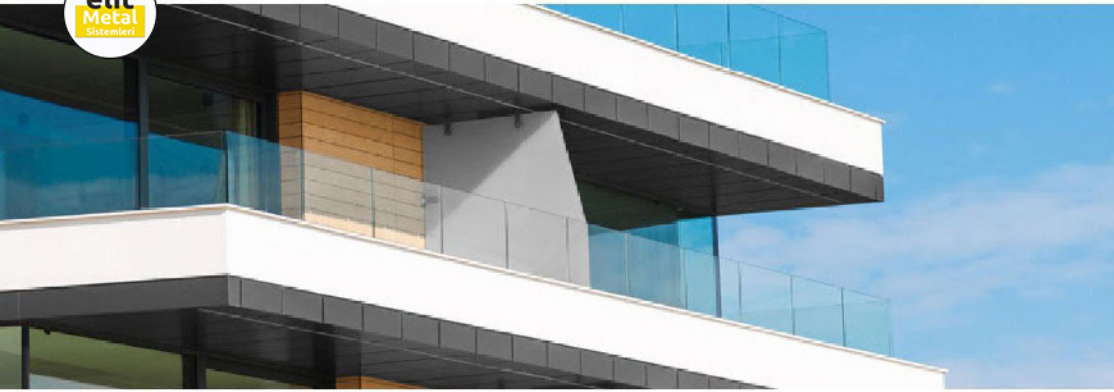

CL50



ABP
CERTIFIED
PRODUCT



6+6 mm / 8+8 mm Glass

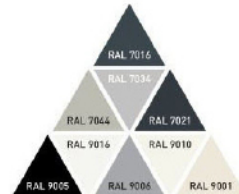
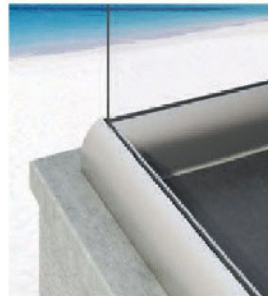
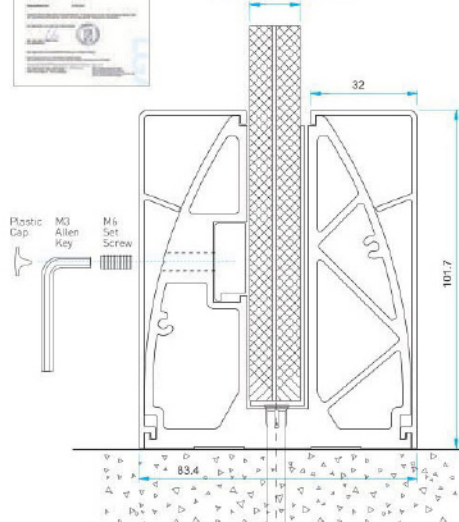

CL50

System zur Befestigung auf dem Boden / Système Connecté Au Sol

Glass Support Base Shoes



CL50-7276



CL50-7276/30

Code	CL50-7276	CL50-7276/30
Length	15 cm	30 cm
Glass Thickness	12,4 mm / 17,52 mm Glass	
Prefabricated	✓	✓
Pressing Stick	Included	Included
Spacer	Included	Included
Set screws	Included	Included

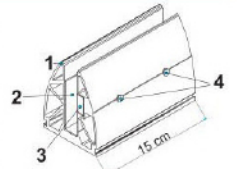

Material List

- 1- Glass support base shoe
- 2- Spacer
- 3- Pressing stick
- 4- M6 Set screw

Covers



CL50-7277



CL50-7279



Endcaps



CL50-7277K



CL50-7279K

Fixing Components



VJ10X140
Universal Anchor

Gasket



Glass Thickness		CL50
12 mm (13,76 mm)	Interior Gasket	CNT-022

* Epoxy gaskets are sold on a box basis.

Installation Details

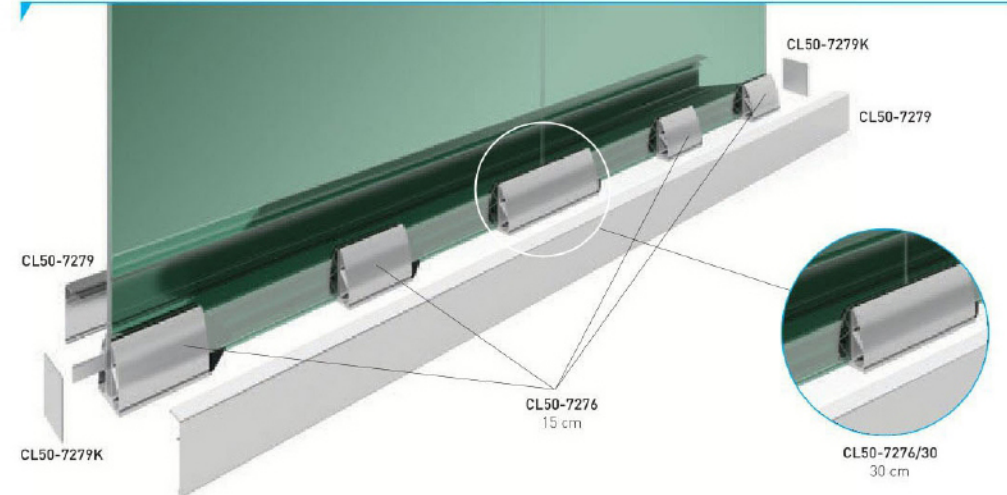



CL40

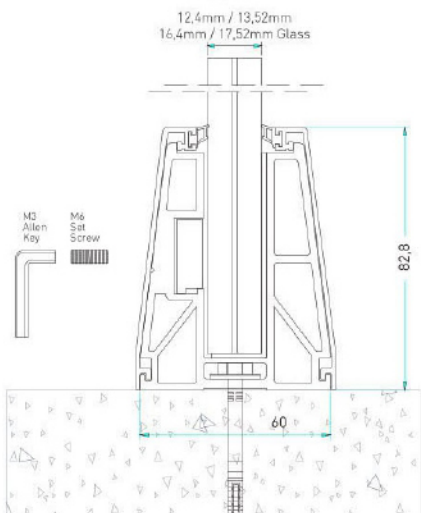
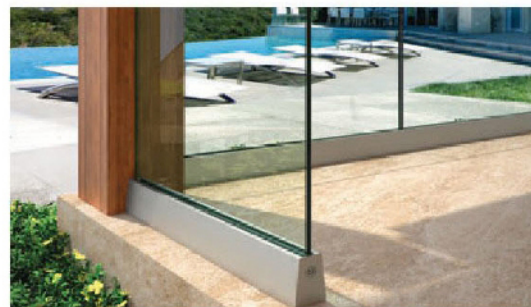

CL40

System zur Befestigung auf dem Boden / Système Connecté Au Sol

Glass Support Base Shoes



- Material List**
- 1- Glass support base shoe
 - 2- Spacer
 - 3- Pressing stick
 - 4- M6 Set screw

Code	CL40-9189	CL40-9189/30	CL40-5345	CL40-5345/30
Length	15 cm	30 cm	15 cm	30 cm
Glass Thickness	12,4mm/ 13,52 mm Glass		16,4mm/ 17,52 mm Glass	
Prefabricated	✓	✓	✓	✓
Pressing Stick	Included	Included	Included	Included
Spacer	Included	Included	Included	Included
Setscrews	Included	Included	Included	Included

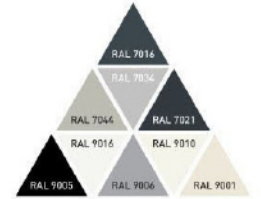

Covers



CL40-9190



Endcaps



CL40-9190K

Fixing Components



KB10X140

Gaskets



Glass Thickness	CL40	
12 mm (13,76 mm)	Interior Gasket	CNT-026
	Outer Gasket	CNT-026
16 mm (17,52 mm)	Interior Gasket	CNT-025
	Outer Gasket	CNT-025

• Epcim gaskets are sold on a box basis.

Installation Details

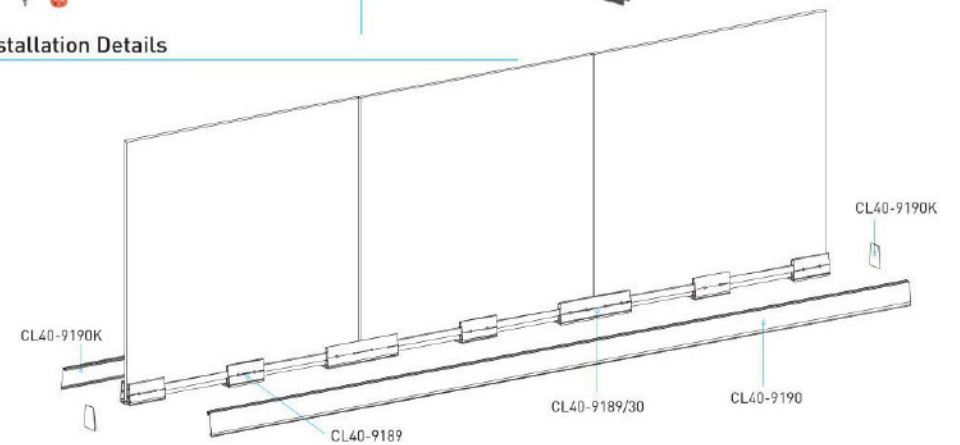

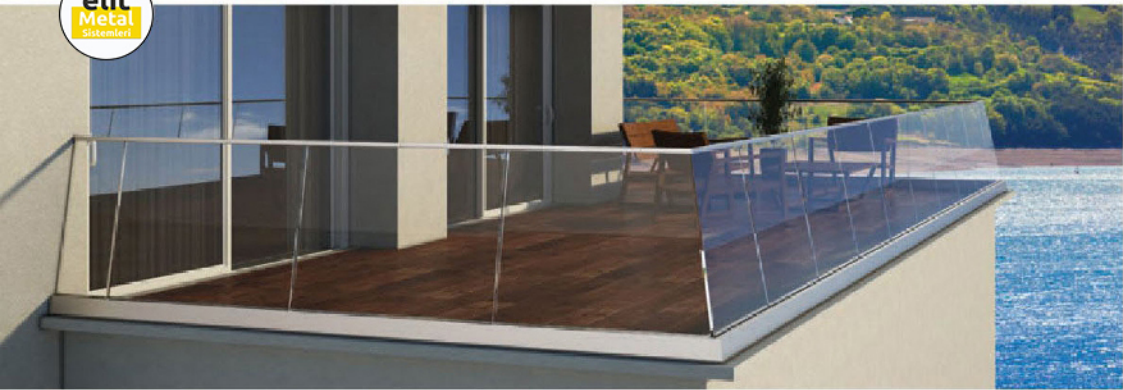

RX50

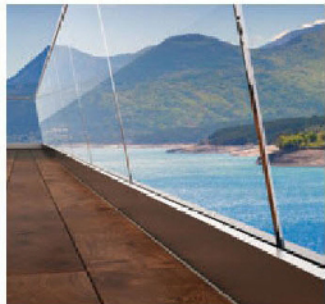
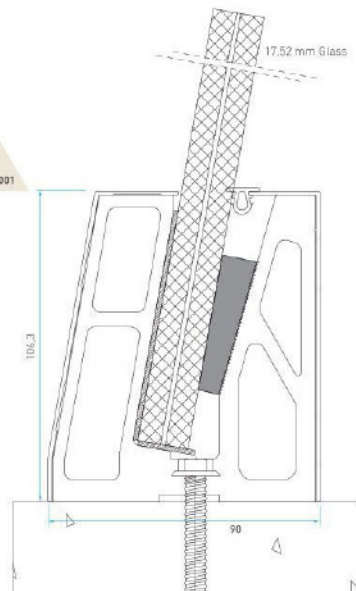
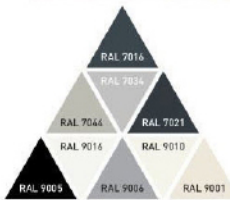

RX50

System zur Befestigung auf dem Boden / Système Connecté Au Sol

Glass Support Base Shoes

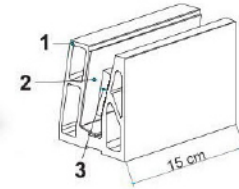

- Material List**
 1- Glass support base shoe
 2- Spacer
 3- Plastic wedge

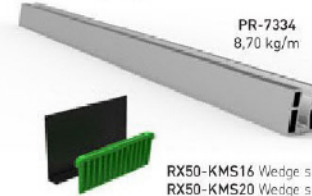

Code	RX50-7334	RX50-7334-30	RX50-5325	RX50-5325-30	PR-7334
Length	15 cm	30 cm	15 cm	30 cm	200 cm
Glass Thickness	16,4 mm / 17,52 mm Glass		20,4 mm / 21,52 mm Glass		16,4 mm / 21,52 mm
Prefabricated	✓	✓	✓	✓	Upon Request
Plastic Wedge +Spacer	Included	Included	Included	Included	X



RX50-KMS16 Wedge set for 8+8 mm Glass
RX50-KMS20 Wedge set for 10+10 mm Glass

Covers

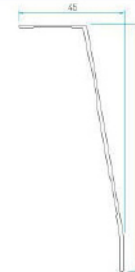

Endcaps



Fixing Components

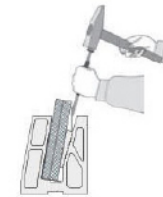

Gaskets



Glass Thickness	Interior Gasket	RX50
16 mm (17,52 mm)	Interior Gasket	CNT-023
20 mm (21,52 mm)	Interior Gasket	FT11

• Epdm gaskets are sold on a box basis.

Installation Details

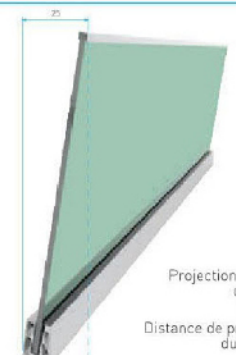
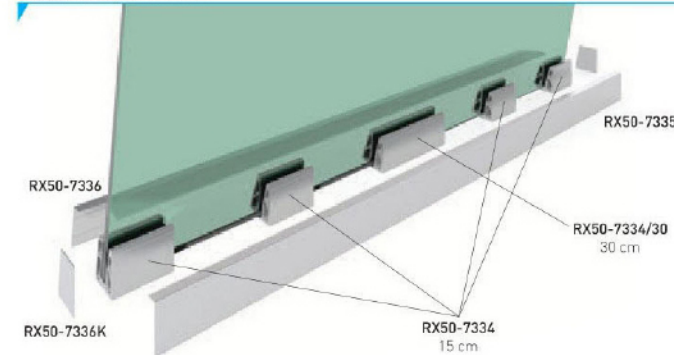

Projection distance of system
 Neigung
 Distance de projection du système



CA50

Mass/Block/Masse: 9.89846 kg
 Volume/Volumen/Volume: 0.000517958 m³
 Density/Dichte/Densité: 2700 kg/m³
 Weight/Gewicht/Poids/Force: 13.7052 N

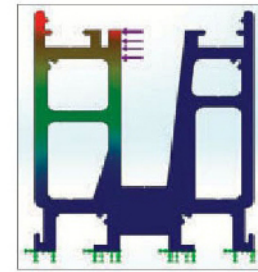
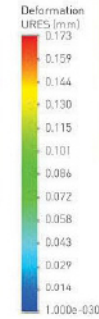

In Boden versenkte Befestigung / Système Connecté Sous Sol

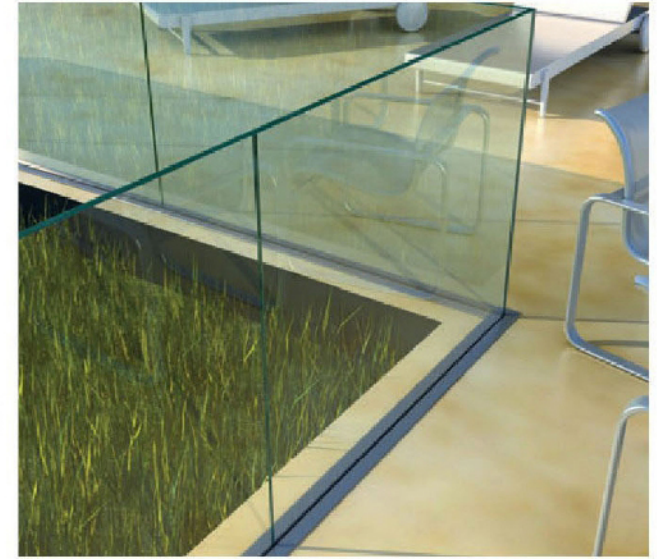

Alloy EN AW 6063
 Stress and relocation results on 1m base profile with 1 tone (10.000 nt) horizontal load to the highest surface of the profile.

Belastungs- und Verlagerungsergebnisse auf 1 m Basis Profil bei Belastung mit 1 Tonne (10.000 NT), horizontale Belastung auf der höchsten Oberfläche des Profils.

EN AW 6063
 Le stress et le démenagement résultant sur la surface la plus haute de profilé de base de 1 m à la suite d'une charge horizontale de 1000 kg.

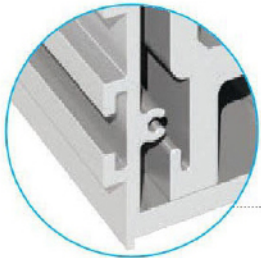
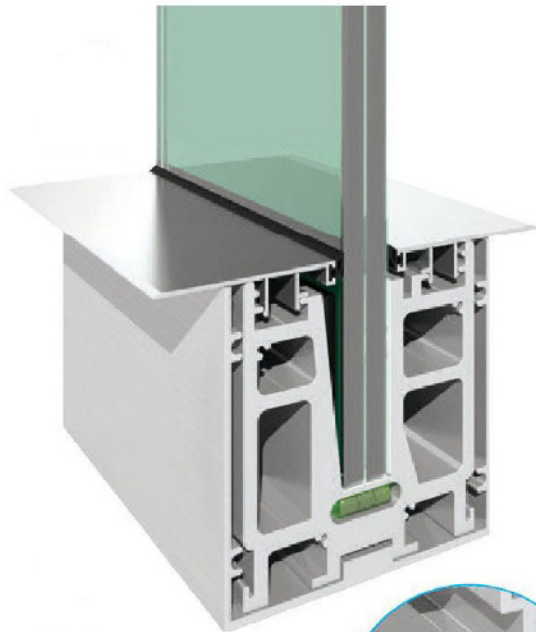

Height Adjusting Profile
 Höheneinstellungsprofil
 Définitions des onglets

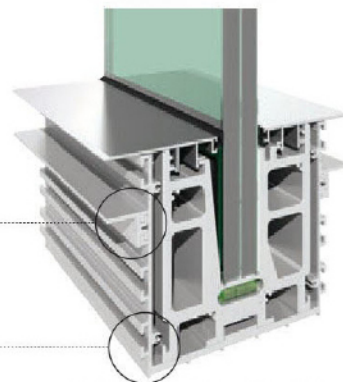
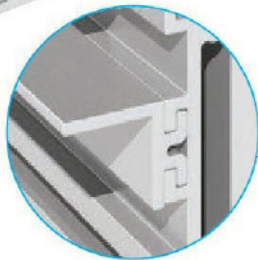

Height Adjusting U Case Profile Option
 Höheneinstellungsprofil für U Gehäuse
 Option pour cadre réglable

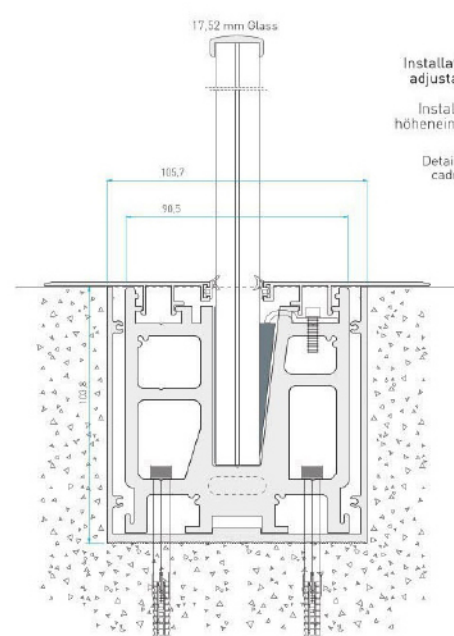

Installation detail of height adjustable U case profile
 Installationsdetails für höheninstellbare U Gehäuse

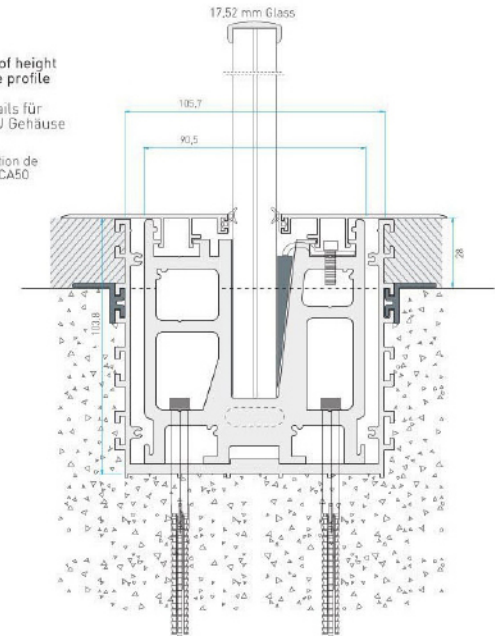

Details d'application de cadre réglable CA50

Glass Support Base Shoes



Full Length Base Channel Profile



Gaskets

Glass Thickness	CA50	
10 mm	Interior Gasket	CNT-029
	Outer Gasket	CNT-025
12 mm (13,76 mm)	Interior Gasket	CNT-026
	Outer Gasket	CNT025
16 mm (17,52 mm)	Interior Gasket	CNT025
	Outer Gasket	CNT-025
20 mm (21,52 mm)	Interior Gasket	CNT-025
	Outer Gasket	CNT-025

• Epdm gaskets are sold on a box basis.

Code	C50-5280	C50-5280/30	C50-6548	C50-6548/30	C50-6844	C50-6844/ 30	P-1001	P-1006
Length	15 cm	30 cm	15 cm	30 cm	15 cm	30 cm	200 cm	200 cm
Glass Thickness	12,4mm/ 13,52 mm Glass		16,4mm/ 17,52 mm Glass		20,4mm/ 21,52 mm Glass		12,4 / 17,52 mm	20,4 / 21,52 mm
Prefabricated	✓	✓	✓	✓	✓	✓	Upon Request	Upon Request
Plastic Wedge	Included	Included	Included	Included	Included	Included	X	X
Spacer	Included	Included	Included	Included	Included	Included	X	X
Wedge Locking	Included	Included	Included	Included	Included	Included	X	X

Covers

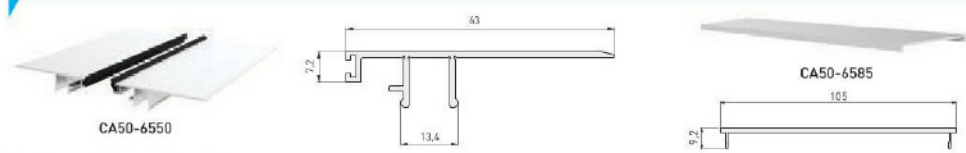

System U Case Profiles



Fixing Components



CA50

In Boden versenkte Befestigung / Système Connecté Sous Sol

Installation Details

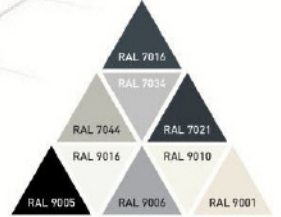
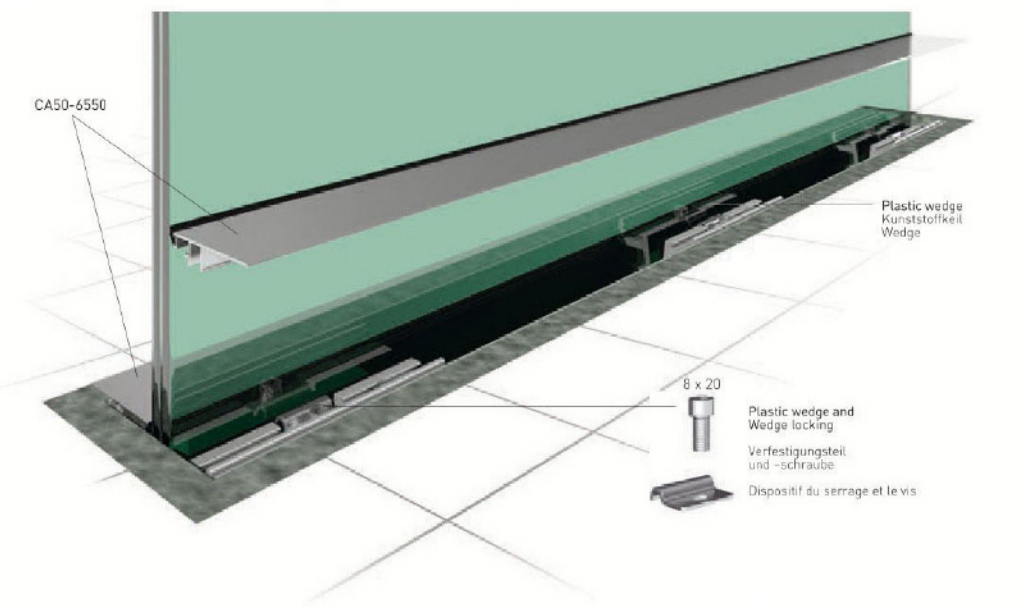
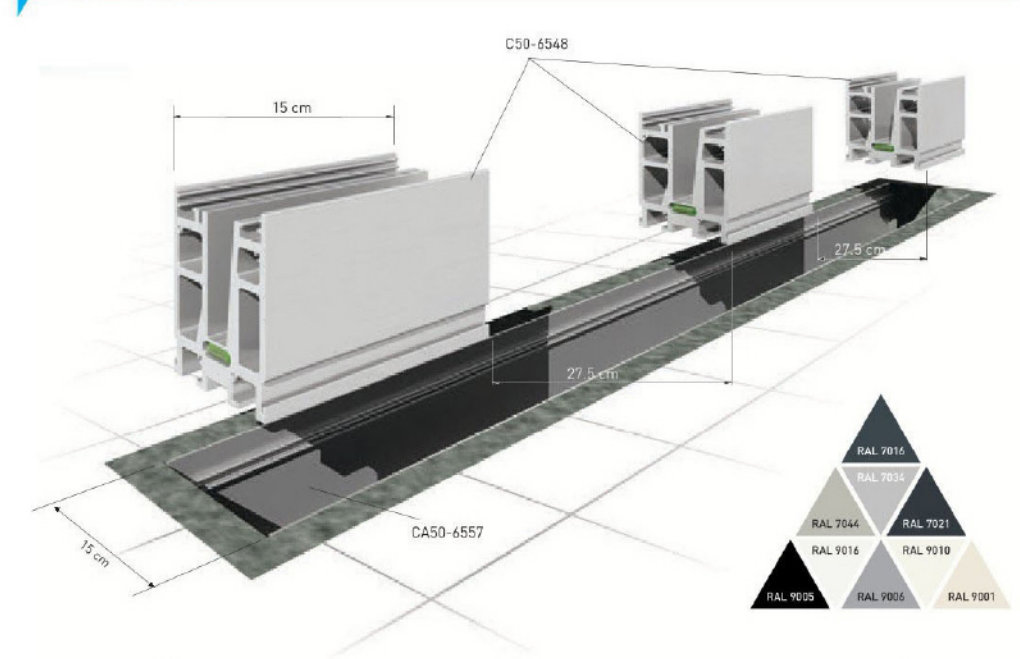



CX50

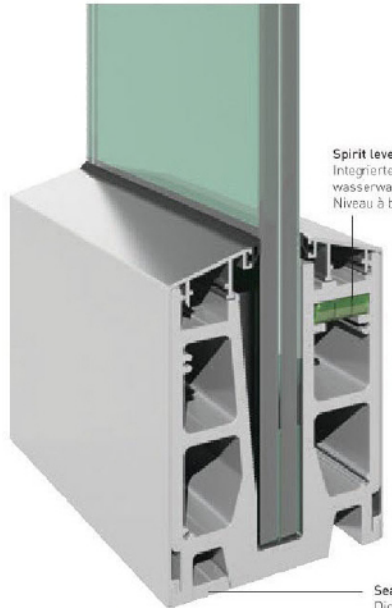

Spirit level
Integrierte
wasserwaage
Niveau à bulle



Sealing profile
Dichtungsprofile
Profilé d'étanchéité

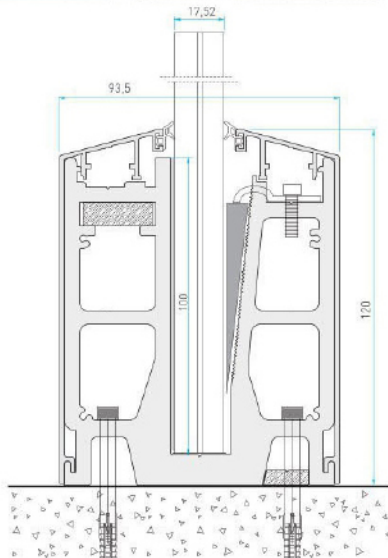
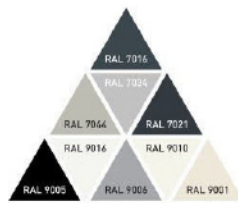

CX50

System zur Befestigung auf dem Boden / Système Connecté Au Sol

Glass Support Base Shoes



- Material List**
 1- Glass support base shoe
 2- Bubble level
 3- Spacer
 4- Plastic wedge

Full Length Base Channel Profile



Gaskets

Glass Thickness		CX50
16 mm (17,52 mm)	Interior Gasket	CNT-025
	Outer Gasket	CNT-025

* Epdm gaskets are sold on a box basis.



Code	CX50-5284	CX50-5284/30	CX50-7646	CX50-7646/30	PR-7646
Length	15 cm	30 cm	15 cm	30 cm	200 cm
Glass Thickness	12,4 mm / 13,52 mm Glass		16,4 mm / 17,52 mm Glass		12,4mm / 17,52mm
Prefabricated	✓	✓	✓	✓	Upon Request
Plastic Wedge +Spacer	Included	Included	Included	Included	X

Covers



Endcaps

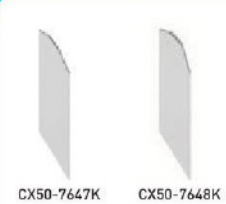

Alignment Profile



Fixing Components



VJ10X140
Universal Anchor



AK-5299
Wedge Fixing Tool

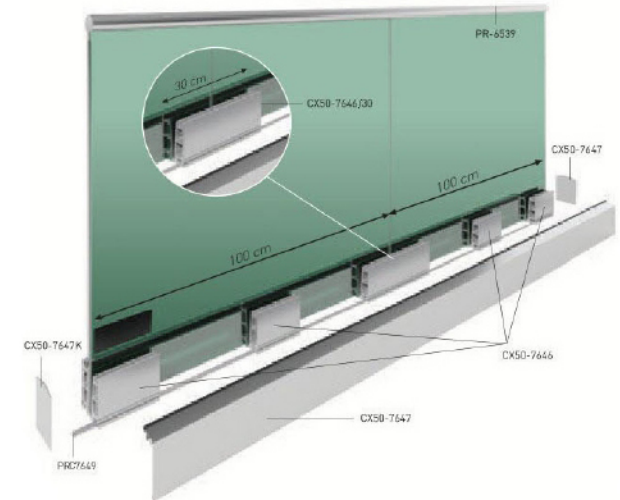



D50

- Detail of linear profile application
- Anwendungsdetail des Linearen Profils
- Détails de l'utilisation de profil en toute longueur

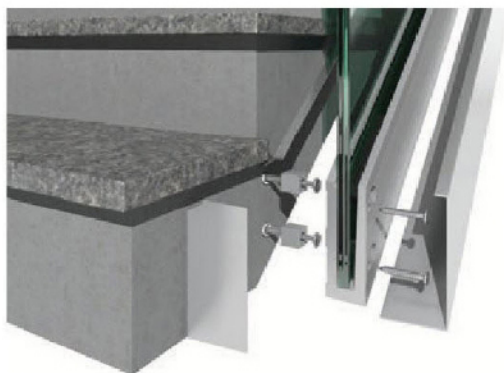

- Detail of piece by piece application
- Anwendungsdetail für Stücke
- Détail de l'utilisation du profil en longueur choisie

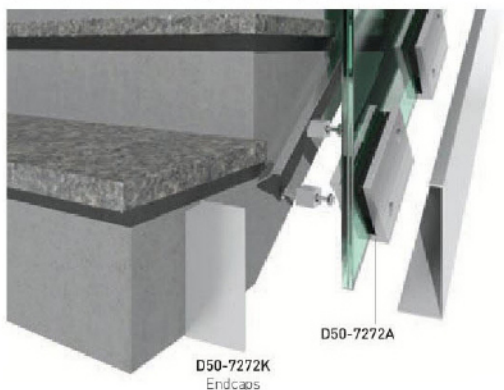

D50

Treppentyp Glasgeländer / Montage direct à la paroi latérale

Glass Support Base Shoes



D50-7272
15 cm Standard Block



D50-7272-A
15 cm Adjustable Block

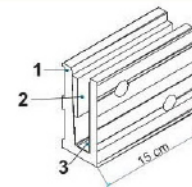

- Material List**
- 1- Glass support base shoe
 - 2- Spacer
 - 3- Plastic wedge

Full Length Base Channel Profiles



D50-7272L2M
10,30 kg/m
2 m Standard Support Profile



D50-7272AL2M
2 m Adjustable
Support Profile



D50-KM16
(8+8 mm Glass)
D50-KM20
(10+10 mm Glass)



BTS-LP1
(100 cm)

Code	D50-7272	D50-7272-A	D50-5335	D50-5335-A	D50-7272 L2M	D50-7272 AL2M
Length	15 cm	15 cm	15 cm	15 cm	200 cm	200 cm
Glass Thickness	16,4 mm / 17,52 mm Glass		20,4 mm / 21,52 mm Glass		16,4 mm / 17,52 mm Glass 20,4 mm / 21,52 mm Glass	
Prefabricated	✓	✓	✓	✓	✓	Upon Request
Plastic Wedge +Spacer	Included	Included	Included	Included	X	X
Adjusting Supports	X	Included	X	Included	X	Included

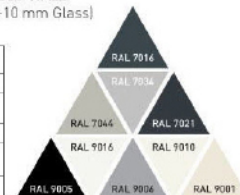

Covers

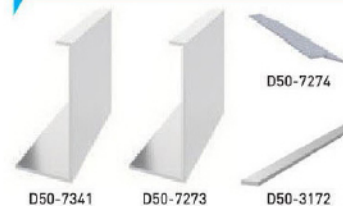

Gaskets



* Epdm gaskets are sold on a box basis.

Fixing Components

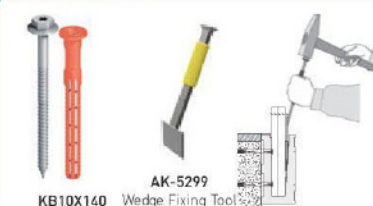

Installation Details

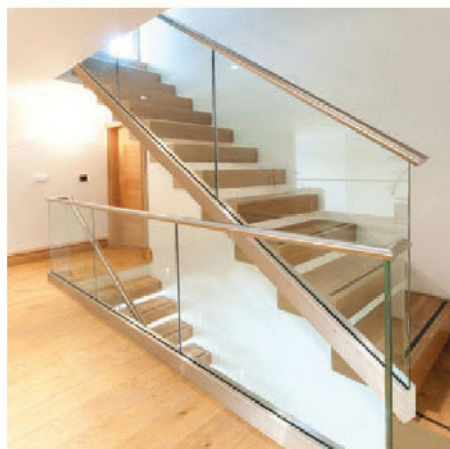
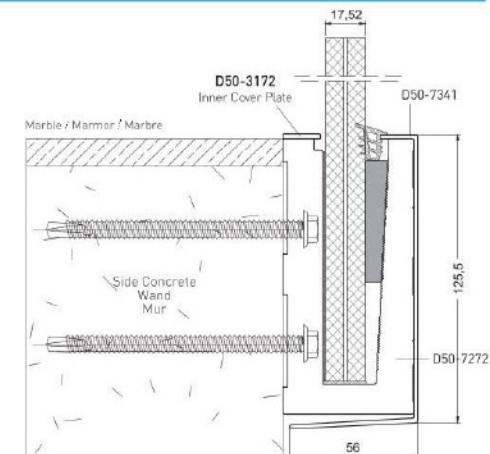
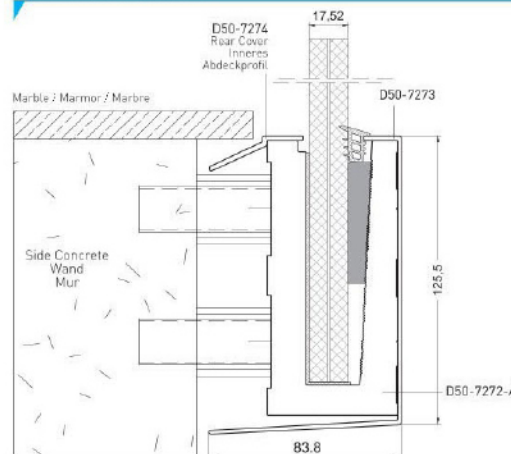



D55



ABP
CERTIFIED
PRODUCT

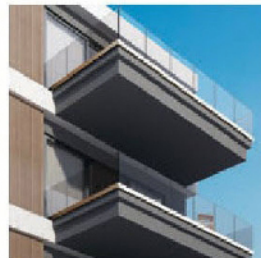
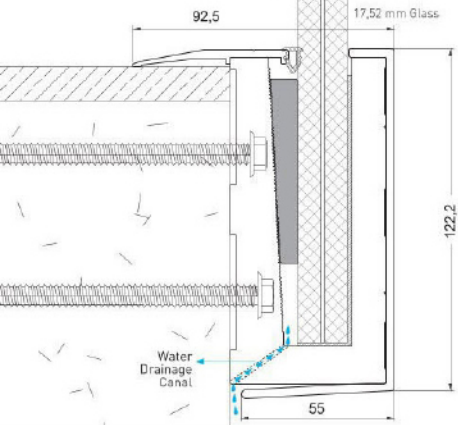

D55

Biegsames Glasgeländersystem zur externen Befestigung
Système de rampe en verre centrable avec connection frontale

Glass Support Base Shoes



D55-7927

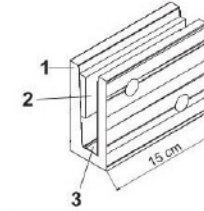

- Material List**
- 1- Glass support base shoe
 - 2- Plastic wedge
 - 3- Spacer

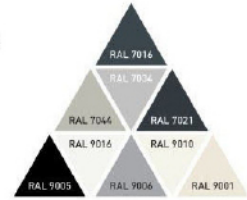

Full Length Base Channel Profiles



D55-7927/2M
9,20 Kg/m



D55-KM16
(8+8 mm Glass)
D55-KM20
(10+10 mm Glass)



BTS-LP1
(100 cm)

Code	D55-7927	D55-5340	D55-7927/2M
Length	15 cm	15 cm	200 cm
Glass Thickness	16,4 mm / 17,52 mm	20,4 mm / 21,52 mm	16,4 mm / 17,52 mm / 20,4 mm / 21,52 mm
Prefabricated	✓	✓	Upon Request
Plastic Wedge + Spacer	Included	Included	X

Covers



D55-7960
Dual Use For
8+8 mm & 10+10 mm Glass



D55-7928

Gaskets



Glass Thickness	D55	
16 mm (17,52 mm)	Interior Gasket:	CNT-021
20 mm (21,52 mm)	Interior Gasket:	CNT-022

• Epdm gaskets are sold on a box basis.

Endcaps



D55-7927K

Fixing Components



KB10X140



AK-5299
Wedge Fixing Tool

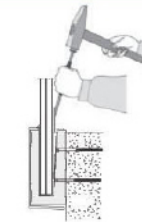

Installation Details

→ Linear Continuous Profile Installation

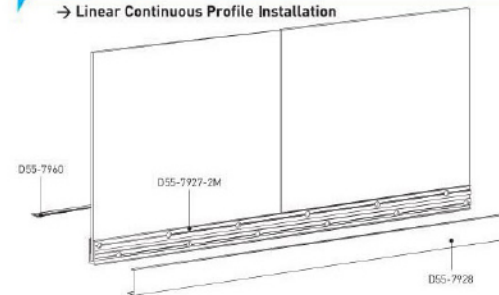

→ Part by Part Installation

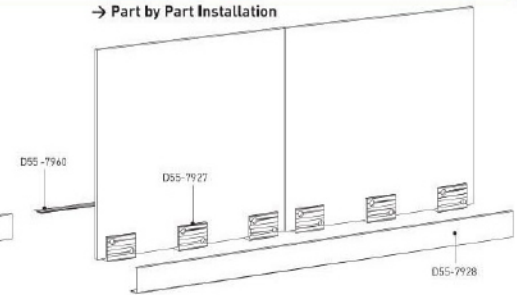



AL50

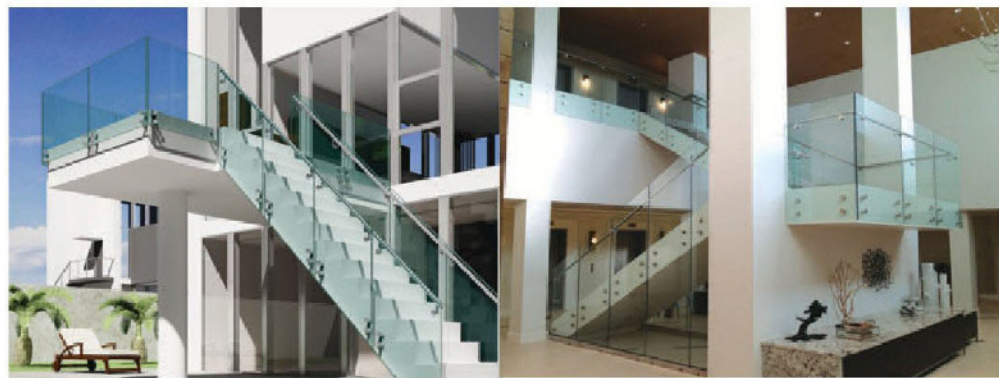

AL50

Seitliches Glas Befestigungssystem / Système de Connexion Latérale

Standoff Glass Adapter

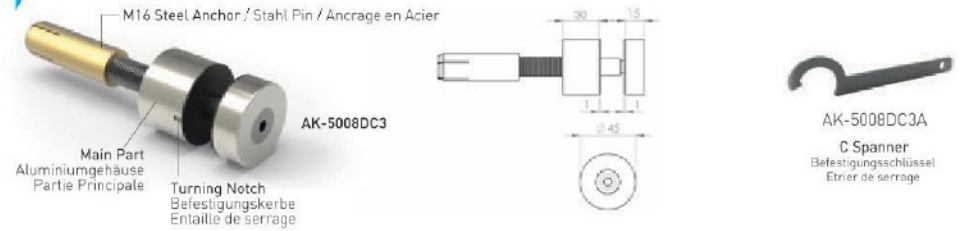

Adjustable Standoff Glass Adapter

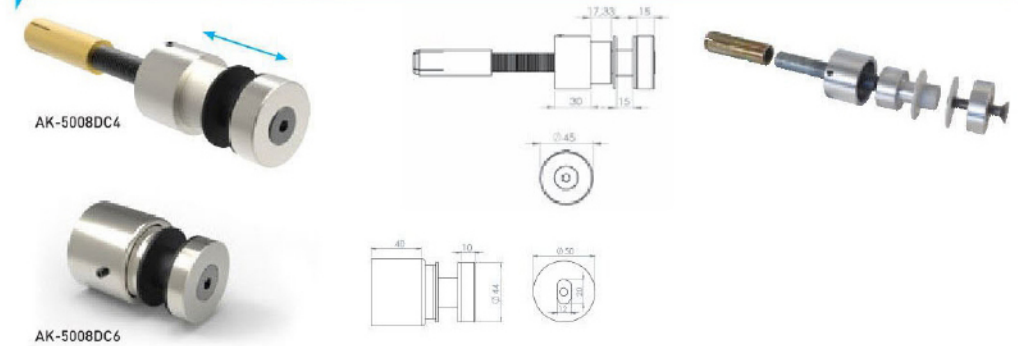

Adjustable Square Standoff Glass Adapter

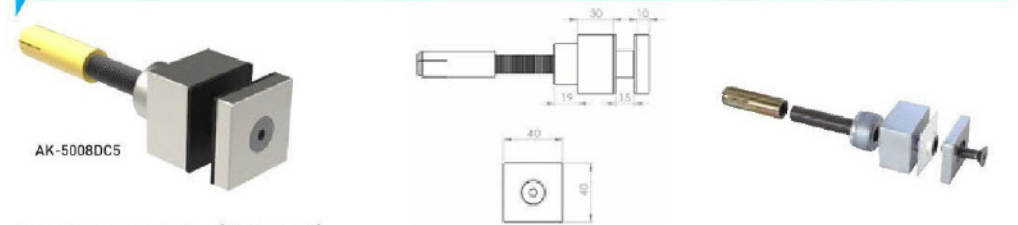

Installation Details (8+8+1,52)

Installation Guide on Glass (Hole Drilling Dimensions)

Montage Entsprechend zum verwendeten Glas [Abmessungen für Glasbohrung]

Schéma d'installation par le verre de 8+8+1,52 (Distance de perçage sur le verre)

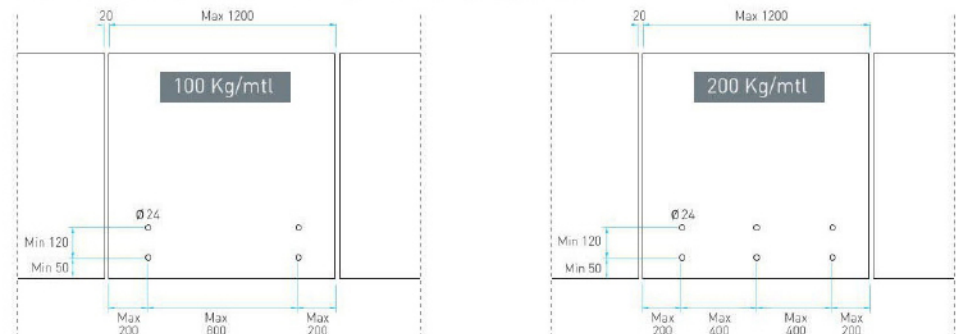



S40

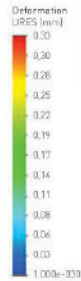

Mass/Block/Masse: 2.77916 kg
Volume/Volumen/Volume: 0.00102932 m³
Density/Dichte/Densité: 2700 kg/m³
Weight/Gewicht/Poids/Force: 27.2358 N

Alloy EN AW 6063
Stress and relocation results on 1 m. base profile with 350 kg horizontal load to the highest surface of the profile.

Belastungs- und Verlagerungsergebnisse auf 1 m. Basis Profil bei Belastung mit 350 kg, horizontale Belastung auf der höchsten Oberfläche des Profils.

EN AW 6063
Le stress et le déménagement résultant sur la surface la plus haute de profilé de base de 1 m. à la suite d'une charge horizontale de 350 kg.

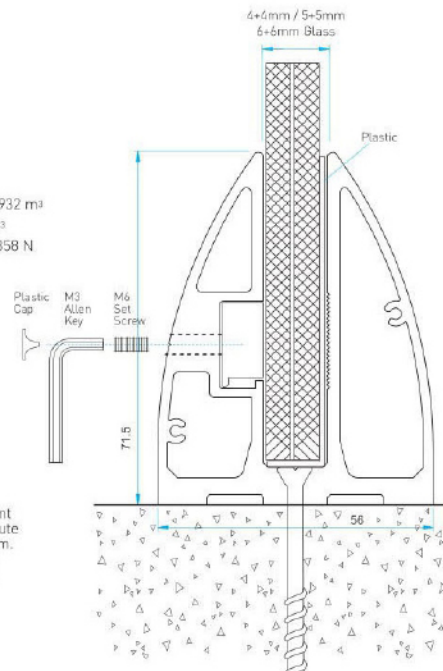

S40

System zur Befestigung auf dem Boden
Système Economique de connexion Au Dessus Du Sol

Glass Support Base Shoes



S40-6981

Code	S40-6981
Length	600 cm / 580 cm
Glass Thickness	8,76 mm / 10,76 mm / 12,76 mm Glass
Finish	Anodized / RAL Powder Coated
Prefabricated	✓
Spacer	✓
Pressing Profile +Set Screws	✓

Glass Adapter



AK-5146
Glass Fixing Accessory
Glas Befestigungszubehör
Accessoire de fixation de verre

Top Rail

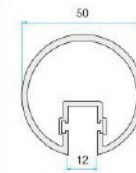

Code: PR-5148
On-Glass Profile
Handläufe
De Profilés sur verre

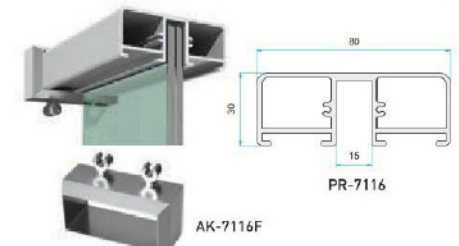

PR-7116

Endcap



S40-6981K

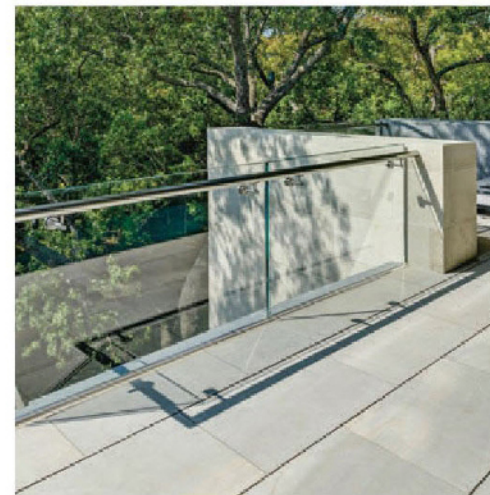



S40E

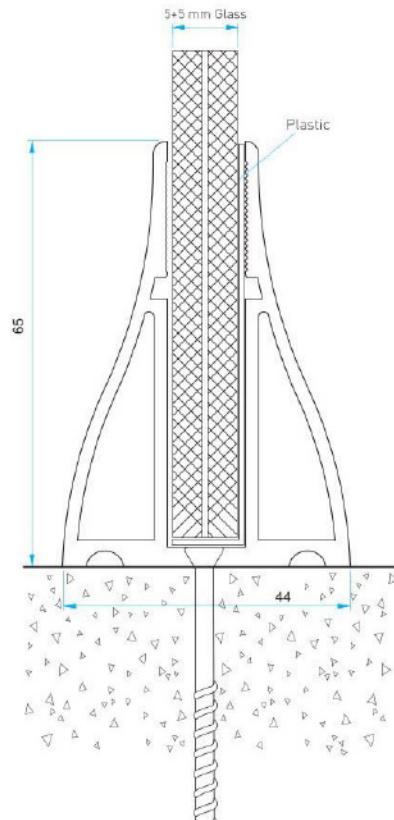

S40E

System zur Befestigung auf dem Boden
Système Economique de connexion Au Dessus Du Sol

Full Length Base Channel Profiles



P-1082
1,526 Kg/m



P-AL8735
1,626 Kg/m

Top Rail

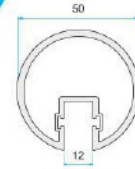

P-AL5148
1,270 Kg/m
On-Glass Profile
Handläufe
De Profiles sur verre

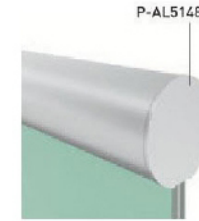

P-AL5148T

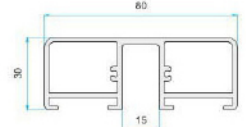

P-AL7116
1,60 Kg/m



AK-7116F

Endcap



S40E-1082K



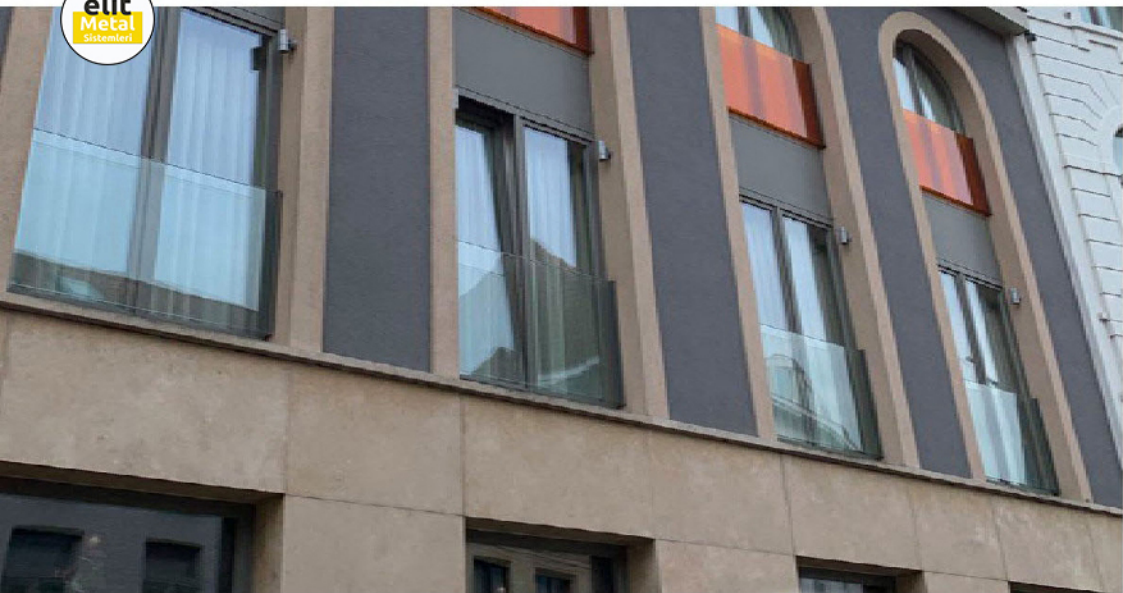

J100

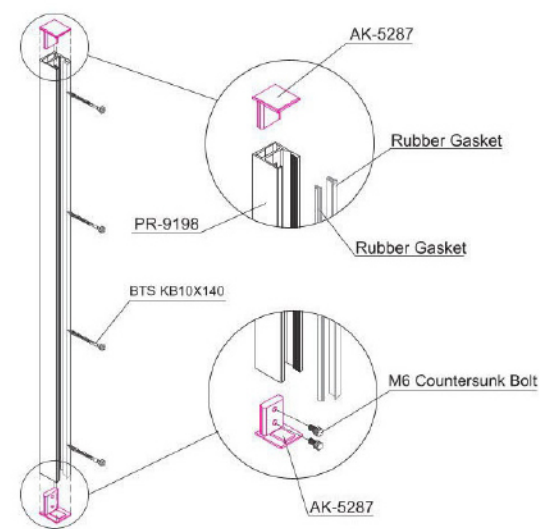

Balcon À la Française / Französischer Balkon

PRE SIZED READY KITS

Finish	Anodized (Matt Natural)		
Height	900 mm	1000 mm	1100 mm
Rubber Set for Glass	Code	Code	Code
10.7 - 13.5 mm	J100.90.10.1	J100.100.10.1	J100.110.10.1
16.7 - 17.5 mm	J100.90.10.2	J100.100.10.2	J100.110.10.2
20 - 21.5 mm	J100.90.10.3	J100.100.10.3	J100.110.10.3
Finish	RAL (Anthracite Gray)		
Height	900 mm	1000 mm	1100 mm
Rubber Set for Glass	Code	Code	Code
10.7 - 13.5 mm	J100.90.20.1	J100.100.20.1	J100.110.20.1
16.7 - 17.5 mm	J100.90.20.2	J100.100.20.2	J100.110.20.2
20 - 21.5 mm	J100.90.20.3	J100.100.20.3	J100.110.20.3
Finish	RAL (White)		
Height	900 mm	1000 mm	1100 mm
Rubber Set for Glass	Code	Code	Code
10.7 - 13.5 mm	J100.90.22.1	J100.100.22.1	J100.110.22.1
16.7 - 17.5 mm	J100.90.22.2	J100.100.22.2	J100.110.22.2
20 - 21.5 mm	J100.90.22.3	J100.100.22.3	J100.110.22.3
Finish	Mill Finish		
Height	900 mm	1000 mm	1100 mm
Rubber Set for Glass	Code	Code	Code
10.7 - 13.5 mm	J100.90.30.1	J100.100.30.1	J100.110.30.1
16.7 - 17.5 mm	J100.90.30.2	J100.100.30.2	J100.110.30.2
20 - 21.5 mm	J100.90.30.3	J100.100.30.3	J100.110.30.3

Do It Yourself



Outer Rubber Gaskets



Inner Rubber Gaskets

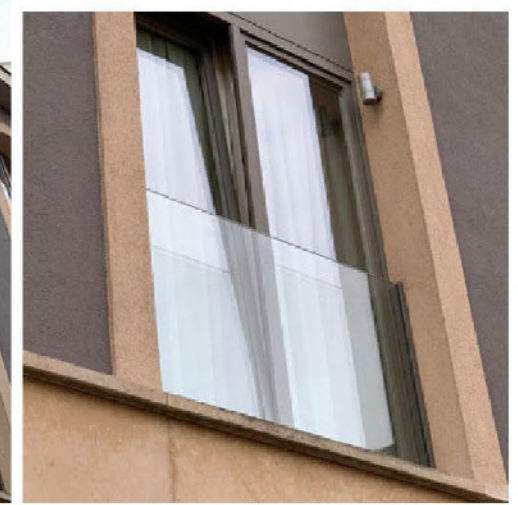
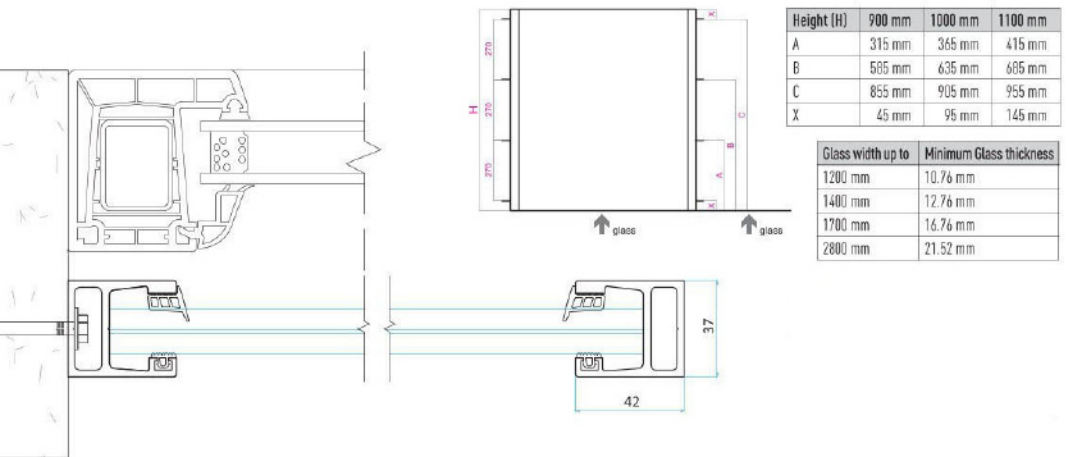



J120

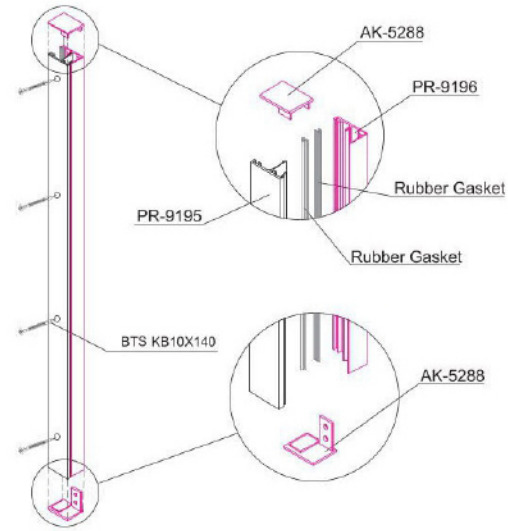

Balcon À la Française / Französischer Balkon

PRE SIZED READY KITS

Finish	Anodized (Matt Natural)		
Height	900mm	1000mm	1100mm
Rubber Set for Glass	Code	Code	Code
10.7 - 13.5mm	J120.90.10.1	J120.100.10.1	J120.110.10.1
16.7 - 17.5mm	J120.90.10.2	J120.100.10.2	J120.110.10.2
20 - 21.5mm	J120.90.10.3	J120.100.10.3	J120.110.10.3

Finish	RAL (Anthracite Gray)		
Height	900mm	1000mm	1100mm
Rubber Set for Glass	Code	Code	Code
10.7 - 13.5mm	J120.90.20.1	J120.100.20.1	J120.110.20.1
16.7 - 17.5mm	J120.90.20.2	J120.100.20.2	J120.110.20.2
20 - 21.5mm	J120.90.20.3	J120.100.20.3	J120.110.20.3

Finish	RAL (White)		
Height	900mm	1000mm	1100mm
Rubber Set for Glass	Code	Code	Code
10.7 - 13.5 mm	J120.90.22.1	J120.100.22.1	J120.110.22.1
16.7 - 17.5 mm	J120.90.22.2	J120.100.22.2	J120.110.22.2
20 - 21.5 mm	J120.90.22.3	J120.100.22.3	J120.110.22.3

Finish	Mill Finish		
Height	900mm	1000mm	1100mm
Rubber Set for Glass	Code	Code	Code
10.7 - 13.5mm	J120.90.30.1	J120.100.30.1	J120.110.30.1
16.7 - 17.5mm	J120.90.30.2	J120.100.30.2	J120.110.30.2
20 - 21.5mm	J120.90.30.3	J120.100.30.3	J120.110.30.3

Do It Yourself



Rubber Gaskets

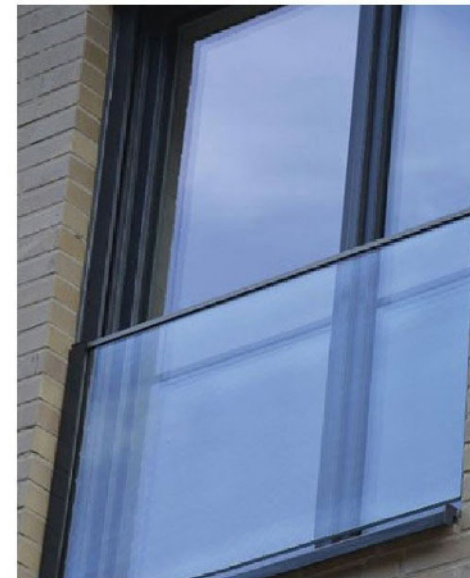
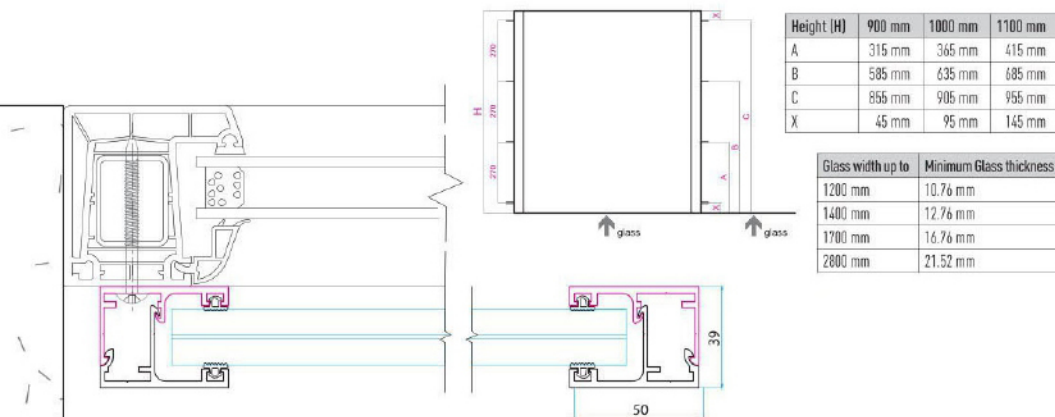



Vista100



Vista100

Seitliches Glas Befestigungssystem
Système de Connexion Latérale

Square Standoff Glass Holder



V100



VJ10X140
Universal Anchor

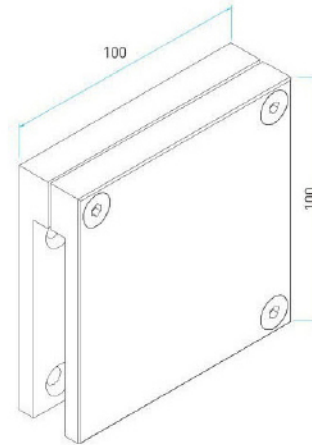

- | | | |
|---|---|--|
| <ul style="list-style-type: none"> • Aesthetic Design • Easy Installation • Unlimited View • Cost Effective | <ul style="list-style-type: none"> • Ästhetisches Design • Einfache Montage • Freie Sicht • Kosteneffizient | <ul style="list-style-type: none"> • Design esthétique • Installation facile • Vue illimitée • Coût efficace |
|---|---|--|





Vista300



V300

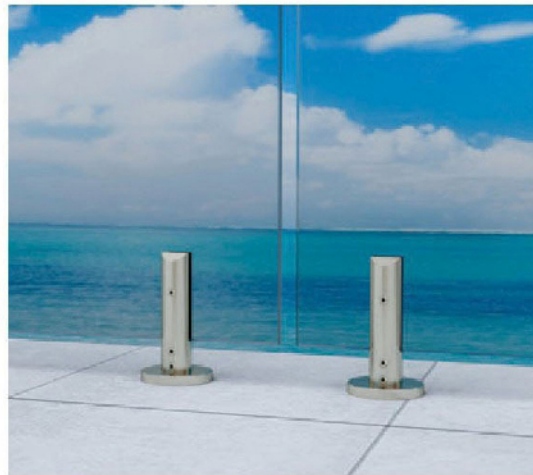
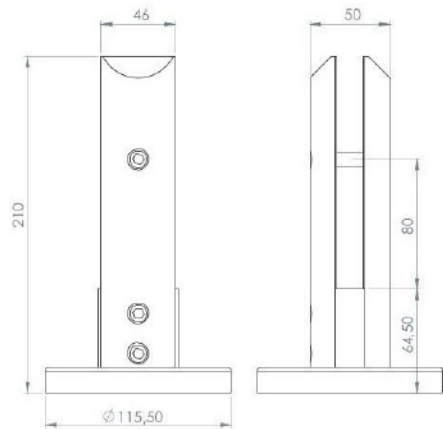

Vista310



V310



V310 Max

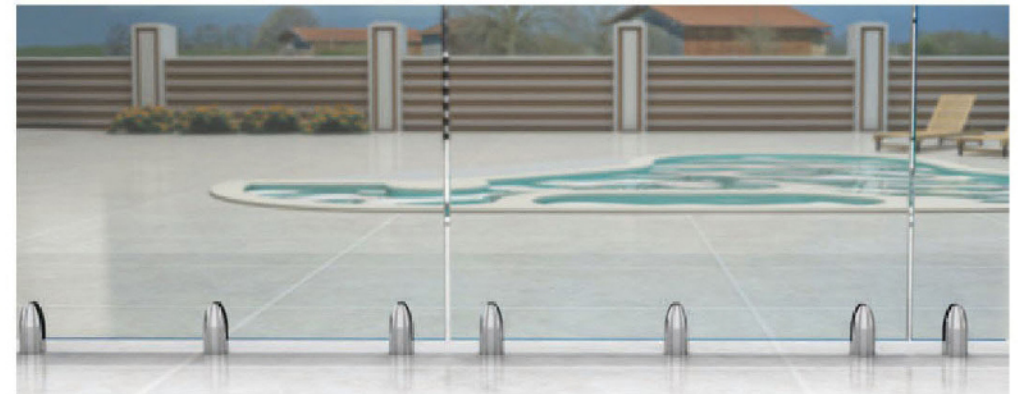
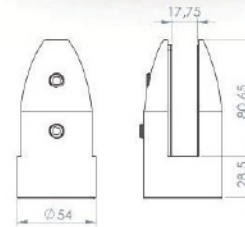



Vista320



V320

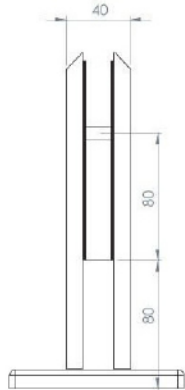
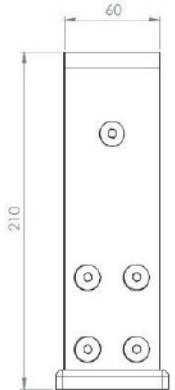

Vista330



V330



V330 Max

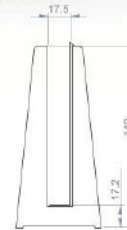
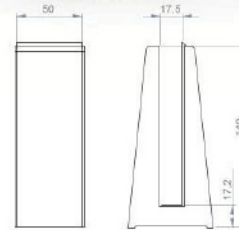



Handläufe / Types de Profilés Sur Verre

On glass profile for 12 mm safety glass with gasket inside
12 mm Glas (mit Dichtung)
Verre de 12 mm avec joint

On glass profile for 16 mm safety glass with gasket inside
16 mm Glas (mit Dichtung)
Verre de 16 mm avec joint

On glass profile for 20 mm safety glass with gasket inside
20 mm Glas (mit Dichtung)
Verre de 20 mm avec joint

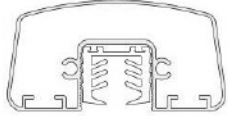

PR-6948/12

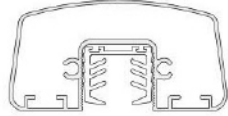

PR-6948

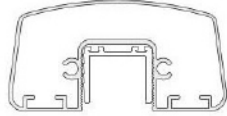

PR-6948/20



PR-6423/12



PR-6423



PR-6423/20

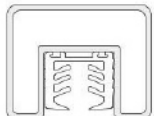

PR-7271/12

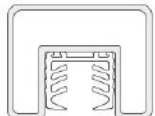

PR-7271

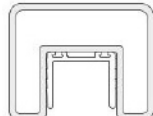

PR-7271/20



PR-9183/12



PR-9183



PR-9183/20



PR-6539/12



PR-6539



PR-6539/20



PR-6832/12



PR-6832



PR-6832/20



PR-6540/12



PR-6540



PR-6540/20



PR-7426



PR-6728



PR-6936

Various Top Rail Options



PR-6528

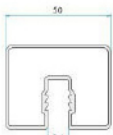

PR-7979



PR-7915

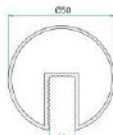

PR-7798



PR-5749



PR-5148

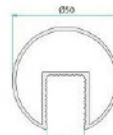

PR-7800



PR-6425



PR-6424



PR-6413

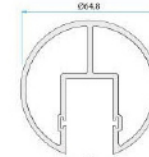

PR-5900



PR-7304

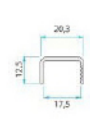

PR-8052



PR-8092



PR-8093

Zubehör für Handläufe / Accessoires de profil Sur Verre

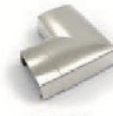

AK-6948D



AK-6948B



AK-6948F



AK-6948TA



AK-6423F



AK-6423B



AK-6423D



AK-6423TS

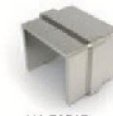

AK-7271B

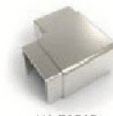

AK-7271D



AK-7271TA



AK-7271F



AK-9183F



AK-9183D



AK-9183B



AK-9183TA



AK-6539F



AK-6539D



AK-6539B



AK-6539TA



AK-6539C



AK-6832F



AK-6832B



AK-6832D



AK-6832T



AK-6540TA



AK-6540F



AK-6540V



AK-6540H



AK-6540KD



AK-6540KD1



AK-6540B



AK-6540T



AK-6540C



AK-6728F



AK-6728D1
90°C Corner



AK-6728D2
135°C Corner



SLIM MODEL

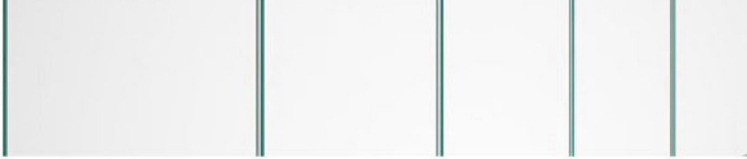

HANDRAILS



SQUARE MODEL



ROUND MODEL



ROUND MODEL



MIDDLE GLASS SUPPORT

ROUND



ROUND MODEL

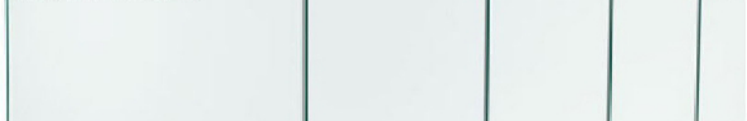

SQUARE

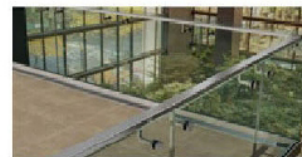



Installation Tools Installationswerkzeug / Outils d'installation



AK-5076
Glass Suction Lifter
Glas Saugnagl
Verre vantouse



AK-5027T
Chemical Silicon and Plug Pistol
Silikon Pistole
Silicone pistolet



AK-5027P
Air Pump
Luftpumpe
Pompe à air



AK5027K
Chemical Anchor
Epoxy Kleber
Glue chimique



AK-5077
Silicon
Silikon
Silicone



AK-5078
Cleaning Spray for Aluminium Surface
Reinigungspray für Aluminium Oberfläche
Pulvérisation nettoyante pour surface d'aluminium



AK-5027D
Adhesive for Aluminium
Aluminium Kleber
Adhésif pour Aluminium



AK-5079
Cutting Machine
Säge
Scie



AK-5079T
Saw
Säge
Scie



AK-5299
Wedge Fixing Tool



AK-5008DC3A
C Spanner
Befestigungsschlüssel
Etrier de serrage

Standards stay the same, innovation never ends...

elit Metal
Sistemleri
EXPERT ON RAILING SYSTEMS